

Serie 85000 - INCH

New

 85000 Pag. 8.7	 85020 Pag. 8.7	 85030 Pag. 8.7	 85040 Pag. 8.8	 85050 Pag. 8.8	 85111 Pag. 8.8	 85116 Pag. 8.9	 85130 Pag. 8.9	 85140 Pag. 8.9
 85150 Pag. 8.10	 85160 Pag. 8.10	 85170 Pag. 8.10	 85180 Pag. 8.11	 85211 Pag. 8.11	 85216 Pag. 8.11	 85223 Pag. 8.12	 85226 Pag. 8.12	 85230 Pag. 8.12
 85240 Pag. 8.13	 85310 Pag. 8.13	 85320 Pag. 8.13	 85325 Pag. 8.14	 85330 Pag. 8.14	 85340 Pag. 8.14	 85350 Pag. 8.15	 85360 Pag. 8.15	 85500 Pag. 8.15
 85510 Pag. 8.16	 85520 Pag. 8.16	 55410 Pag. 8.16	 55420 Pag. 8.16	 55430 Pag. 8.17	 55440 Pag. 8.17	 82241 Pag. 8.17	 88610 Pag. 8.18	 85620 Pag. 8.18
 55625 Pag. 8.18	 85700 Pag. 8.19	 85705 Pag. 8.19	 87800 Pag. 8.19	 55801 Pag. 8.20	 55802 Pag. 8.20	 50980 Pag. 8.21	 50990 Pag. 8.21	 50006 Pag. 8.21

Serie 89000 - INCH

 89000 Pag. 8.27	 89010 Pag. 8.27	 89030 Pag. 8.27	 89040 Pag. 8.28	 89050 Pag. 8.28	 89055 Pag. 8.28	 89106 Pag. 8.29	 89111 Pag. 8.29	 89116 Pag. 8.29
 89130 Pag. 8.30	 89211 Pag. 8.30	 89216 Pag. 8.30	 89223 Pag. 8.31	 89226 Pag. 8.31	 89230 Pag. 8.31	 89310 Pag. 8.32	 89500 Pag. 8.32	 88610 Pag. 8.32
 89700 Pag. 8.33	 50980 Pag. 8.33	 50990 Pag. 8.33	 50006 Pag. 8.33					

RACCORDI AUTOMATICI IN TECNOPOLIMERO - INCH

TECHNOPOLYMERIC PUSH-IN FITTING - INCH

KUNSTSTOFF STECKVERSCHRAUBUNGEN - INCH

RACCORDS INSTANTANÉS EN TECHNOPOLYMÈRE - INCH

RACORDAJE AUTOMÁTICO EN TECNOPOLÍMERO - INCH

CONEXÕES PUSH-IN EM TECNOPOLÍMERO - INCH



Serie 85000 - INCH

La serie 85000 - INCH Aignep, nata per rispondere alle esigenze più spinte nell'ambito dell'automazione pneumatica, offre al cliente più attento la possibilità di utilizzare un prodotto in tecnopolimero, abbinando a prestazioni elevate compattezza e leggerezza.

Gamma completa dal diam. 1/8 - 1/2

Principali vantaggi

- Connessione e sconnessione istantanea
- Pieno passaggio e tenuta al vuoto grazie a guarnizioni sagomate
- Tipologie di filettature, UNF, (universal short)
- Compattezza e riduzione dei pesi
- Gamma con figure specifiche per soddisfare la robotica più spinta
- Silicon Free

Applicazioni

- Robotica
- Automotive
- Industria tessile, imballaggio, manipolazione
- Circuiti aria compressa
- Acqua industriale
- Vuoto

The 85000 - INCH serie came up to answer the most extreme demands of pneumatic automation. It is a line in technopolymer, lighter and more compact which offers to demanding customers high performances.

Wide Range \varnothing 1/8 - 1/2

Main advantages

- Quick connection and disconnection
- Full Flow and Vacuum resistant tank to special shaped seals
- Threads available, UNF, (universal short)
- Lighter and More compact
- Specific configurations to satisfy the advanced robotics
- Silicon Free

Applications

- Robotics
- Automotive
- Textile, Packaging, Handling
- Compressed Air Circuit
- Industrial Water
- Vacuum

Die 85000 - INCH er-Serie wurde als Antwort auf die extremsten Anforderungen in der pneumatischen Automation entwickelt. Diese Serie ist aus Technopolymer, leichter und kompakter, welche anspruchsvollen Kunden hohe Leistungsfähigkeit bietet.

Liefersortiment \varnothing 1/8 - 1/2

Hauptvorteile

- Schnelle Verbindung und Trennung
- Voller Durchfluss und Vakuumfestigkeit, dank spezieller Formdichtungen
- Gewindearten, UNF, (universal short)
- Leichter und kompakter
- Spezielle Konfigurationen, um der fortschrittlichen Robotertechnik gerecht zu werden
- Silikonfrei

Anwendungen

- Robotik
- Automobil-Industrie
- Textil-, Verpackungs-, Handlingindustrie
- Druckluftkreislauf
- Industrielle Wasser
- Vakuum

La série 85000 - INCH répond aux principales attentes dans les applications des automatismes pneumatiques. Cette gamme en technopolymère, plus légère et plus compacte offre aux clients exigeants des performances élevées.

Large gamme \varnothing 1/8 - 1/2

Principaux avantages

- Connexion et déconnexion rapides
- Plein débit et tenue au vide grâce à des joints de forme
- Filetages disponibles, UNF, (universal short)
- Légèreté et compacité
- Configurations spécifiques pour répondre à la robotique de pointe
- Sans silicone

Applications

- Robotique
- Automobile
- Textile, Conditionnement, Manutention
- Circuit Air comprimé
- Eau Industrielle
- Vide industriel

La Serie 85000 - INCH llegó para satisfacer las más extremas demandas de la automatización neumática. Es una línea en tecnopolímero, ligera y más compacta que ofrece a los clientes altas prestaciones.

Amplia gama de \varnothing 1/8 - 1/2

Principales ventajas

- Conexión y desconexión instantánea
- Paso total y estanqueidad al vacío gracias a las juntas moldeadas
- Tipos de roscas, UNF, (universal short)
- Ligero y más compacto
- Configuraciones específicas para satisfacer la robótica avanzada
- Libre de silicona

Aplicaciones

- Automatización Neumática
- Automoción
- Industria textil, envasado, manipulación
- Circuitos de aire comprimido
- Agua Industrial
- Vacío

A série 85000 - INCH veio para atender as mais extremas demandas de aplicações da automação pneumática. É uma linha em tecnopolímero, mais leve e mais compacta que oferece aos clientes performances mais altas.

Grande range de itens : 1/8 - 1/2

Principais vantagens

- Rápida conexão e desconexão
- Vazão total e resistência ao vácuo graças ao design de suas vedações
- Tipos de rosca disponíveis, UNF, (universal short)
- Leveza e compacidade
- Configurações específicas para atender robótica avançada
- Livre de Silicone

Aplicações

- Robótica
- Automotiva
- Têxtil, Embalagem, Manipulação
- Circuitos de Ar Comprimido
- Água Industrial
- Vácuo



CARATTERISTICHE TECNICHE

TECHNICAL CHARACTERISTICS
TECHNISCHE ANGABEN
CARACTÉRISTIQUES TECHNIQUES
CARACTERÍSTICAS TÉCNICAS
CARACTERÍSTICAS TÉCNICAS



Norma di Riferimento

Reference standard

Entspricht der Norm

Norme de référence

Normativa de referencia

Norma de referència

1907/2006

REACH

2011/65/CE



PED
2014/68/UE

ISO
14743:2004

SILICON
FREE

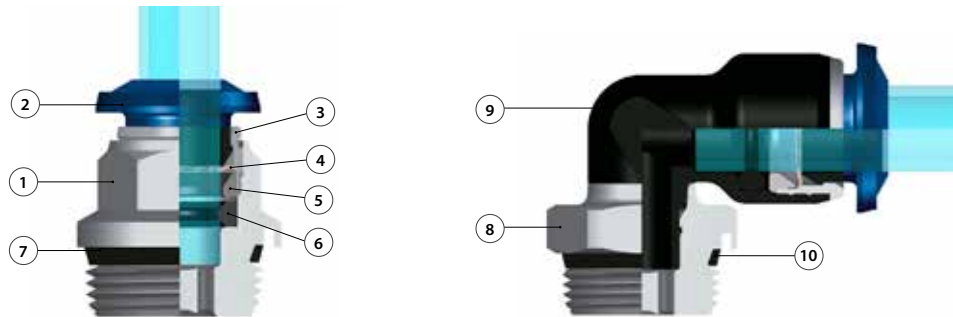

Materiali e Componenti

IT

- 1 Corpo in ottone nichelato
- 2 Spintore sgancio tubo resina acetalea
- 3 Capsula in ottone nichelato
- 4 Pinza d'aggraffaggio in acciaio inox AISI 301
- 5 Anello di posizionamento in tecnopolimero
- 6 Guarnizione sagomata in NBR
- 7 Guarnizione filetto in NBR
- 8 Basetta Filettata in Ottone Nichelato
- 9 Corpo in tecnopolimero PA
- 10 Guarnizione in NBR

Component Parts and Materials

GB

- 1 Nickel-plated brass Body
- 2 Acetalic resin Collet
- 3 Nickel-plated brass Capsule
- 4 Steel AISI 301 Clamping washer
- 5 Technopolymeric positioning ring
- 6 NBR Molded seal
- 7 NBR Thread packing
- 8 Base Threaded Nickel Plated Brass
- 9 Technopolymeric Body PA
- 10 NBR seal

Komponenten und Materialien

DE

- 1 Körper Messing vernickelt
- 2 Rohr Lösering Acetal
- 3 Haltering Messing vernickelt
- 4 Zahnscheibe Edelstahl AISI 301
- 5 Positionierring Technopolymer
- 6 Lippendichtung NBR
- 7 Gewindeabdichtung NBR
- 8 Gewindebasis Messing vernickelt
- 9 Körper Technopolymer PA
- 10 Lippendichtung NBR

Matériaux et Composants

FR

- 1 Corps: Laiton nickelé
- 2 Pousoir: Résine acétal
- 3 Capsule de retenue: Laiton nickelé
- 4 Rondelle d'accrochage: AISI 301
- 5 Anneau de positionnement: Technopolymère
- 6 Joint à lèvres: NBR
- 7 Joint d'étanchéité du filetage: NBR
- 8 Bague de sécurité en laiton nickelé
- 9 Corps: Technopolymère PA
- 10 Joint en NBR

Materiales y Componentes

ES

- 1 Cuerpo en latón niquelado
- 2 Anillo de extracción tubo en resina acetalica
- 3 Cápsula en latón niquelado
- 4 Pinza de agarre en acero inox AISI 301
- 5 Anillo de posicionamiento en tecnopolimero
- 6 Junta de forma en NBR
- 7 Junta rosca en NBR
- 8 Base roscada en latón niquelado
- 9 Cuerpo en tecnopolimero PA
- 10 Junta en NBR

Materiais e Componentes

PT

- 1 Corpo em latão niquelado
- 2 Anilha de liberação do tubo em resina acetálica
- 3 Cápsula de latão niquelado
- 4 Pinça de travamento em aço-inox AISI 301
- 5 Anel de posicionamento em tecnopolímero
- 6 Vedação em NBR
- 7 Vedação da rosca em NBR
- 8 Base roscada em latão niquelado
- 9 Corpo em tecnopolímero PA
- 10 Vedação em NBR



Pressioni

Pressures

Druckbereich

Pressions

Presiones

Pressões

- 0.99 bar (-0.099 MPa)

20 bar (2.0 MPa)



Temperature

Temperatures

Temperatur

Températures

Temperaturas

Temperaturas

- 20 °C

+ 80 °C



Fluidi compatibili

Aria compressa / Vuoto / Acqua

Fluids

Compressed air / Vacuum / Water

Geeignete Medien

Druckluft / Vakuum / Wasser

Fluides compatibles

Air comprimé / Vide / Eau

Fluidos compatibles

Aire comprimido / Vacío / Agua

Fluidos compatíveis

Ar comprimido / Vácuo / Água



Tubi di Collegamento

IT

Tubi in materiale plastico:

PA6, PA11, PA12, Polietilene, *Poliuretano, PTFE, FEP.

*Per tubi in Poliuretano è consigliata una durezza di 98 shore.

Connection Tubes

GB

Plastic tubes:

PA6, PA11, PA12, Polyethylene, *Polyurethane, PTFE, FEP.

*For Polyurethane hoses it is required a minimum hardness of 98 shore.

Geeignete Rohre

DE

Kunststoffrohre:

PA6, PA11, PA 12, Polyethylene, *Polyurethan, PTFE, FEP.

*Für Polyurethan Rohre ist eine Härte von 98 Shore empfohlen.

Tubes Conseillés

FR

Tubes plastiques:

PA6, PA11, PA12, Polyéthylène, *Polyuréthane, PTFE, FEP.

*Pour les tubes en polyuréthane, il est conseillé une dureté de 98 Shore.

Tubos de Conexión

ES

Tubos en material plástico:

PA6, PA11, PA 12, Polietileno, *Poliuretano, PTFE, FEP.

*Para tubos en poliuretano es aconsejada una dureza de 98 shore.

Tubos de Conexão

PT

Tubos em material plástico:

PA6, PA11, PA12, Polietileno, *Poliuretano, PTFE, FEP.

*Para tubos em Poliuretano é requerida uma dureza de 98 shore.



Filettatura IT Gas conica "UNIVERSAL SHORT". Gas cilindrica conforme ISO 228 Classe A. Metrica conforme ISO R/262. Gas cilindrica UNF conforme ANSI B1.1 NPTF metrica conforme ANSI B1.20.5	Threads GB "UNIVERSAL SHORT" Tapered thread. Parallel gas in conformity with ISO 228 Class A. Metric in conformity with ISO R/262. Parallel gas UNF conformity with ANSI B1.1 Metric NPTF conformity with ANSI B1.20.5	Gewindearten DE Konisches Gewinde "UNIVERSAL SHORT". Zylindrisches Gewinde nach Norm ISO 228 Classe A. Metrisches Gewinde nach Norm ISO R/262. Zylindrisches Gewinde UNF nach Norm ANSI B1.1 Metrisches NPTF nach Norm ANSI B1.20.5
Filetages FR Filetage conique "UNIVERSAL SHORT". Filetage cylindrique conforme: ISO 228 Class A. Filetage métrique conforme: ISO R/262. Filetage cylindrique UNF conforme ANSI B1.1 NPTF métrique conforme ANSI B1.20.5	Roscas ES Gas cónica "UNIVERSAL SHORT". Gas cilíndrica conforme ISO 228 Clase A. Métrica conforme ISO R/262. Gas cilíndrica UNF conforme ANSI B1.1 NPTF Métrica conforme ANSI B1.20.5	Roscas PT Gas cónica "UNIVERSAL SHORT". Gas paralela conforme ISO 228 Classe A. Métrica conforme ISO R/262. Gas paralela UNF conforme ANSI B1.1 NPTF Métrica conforme ANSI B1.20.5



UNIVERSAL SHORT

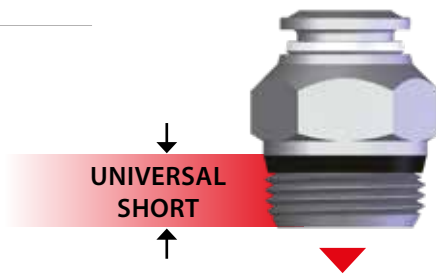

 NPT NPTF Conica Tapered Konisch Conique Cónica Cônica	 ISO 7 BSPP Cilindrica Paralell Zylindrisch Cylindrique Cilíndrica Paralela	 ISO 7 BSPT PT Conica Tapered Konisch Conique Cónica Cônica	 ISO 228 BSP PF Cilindrica Paralell Zylindrisch Cylindrique Cilíndrica Paralela
-------------------------------------------------------------------------------------------------------------------------------------------------------------------------------	----------------------------------------------------------------------------------------------------------------------------------------------------------------------------------------------------	----------------------------------------------------------------------------------------------------------------------------------------------------------------------------------------------	--------------------------------------------------------------------------------------------------------------------------------------------------------------------------------------------------------------------

"UNIVERSAL SHORT" IT La filettatura conica "UNIVERSAL SHORT" è progettata per soddisfare le seguenti caratteristiche: <ul style="list-style-type: none"> • ridurre la lunghezza d'ingombro; • ridurre la chiave rispetto ad alcuni raccordi con filettature cilindriche; • consentire l'accoppiamento con diversi standard di filettature femmina sia coniche che cilindriche. 	"UNIVERSAL SHORT" GB The "UNIVERSAL SHORT" taper thread has been designed to offer the following advantages to the users: <ul style="list-style-type: none"> • reduced overall length; • smaller hex dimensions compared to the parallel threads; • to allow the assembly with different female threads both taper as well as parallel. 	"UNIVERSAL SHORT" DE Das konische Gewinde "UNIVERSAL SHORT" ist so konzipiert, dass folgende Vorteile erzielt werden: <ul style="list-style-type: none"> • Reduzierung der Länge des Gewindes - kürzere Montagezeit; • Reduzierung der Schlüsselweite im Vergleich von Verschraubungen mit zylindrischen Gewinden geringerer Lochabstand; • Ermöglicht den Einsatz in verschiedene Gewindearten, sowie in konische- und zylindrische Innengewinde.
"UNIVERSAL SHORT" FR Le filetage conique "UNIVERSAL SHORT" a été conçu pour satisfaire les exigences suivantes: <ul style="list-style-type: none"> • réduire la longueur d'encombrement; • réduire les dimensions hexagonales par rapport au filetage cylindrique; • permettre le montage avec divers taraudages standards soit coniques soit cylindriques. 	"UNIVERSAL SHORT" ES La rosca cónica "UNIVERSAL SHORT" ha sido proyectada para satisfacer las siguientes características: <ul style="list-style-type: none"> • reducir la longitud; • reducir la llave respecto a algunos racores con rosca cilíndrica; • permitir el acoplamiento con diferentes standard de rosca hembra sean cónicas o cilíndricas. 	"UNIVERSAL SHORT" PT A rosca cónica "UNIVERSAL SHORT" é projetada para satisfazer as seguintes características: <ul style="list-style-type: none"> • reduzir o comprimento da conexão; • reduzir o dimensional com relação às rosca paralelas; • permitir o acoplamento da conexão a diferentes tipos de rosca fêmea, sejam elas cónicas ou paralelas.



IT Consentire una completa tenuta anche su superfici non perfettamente piane, concave, convesse o inclinate, con diversi smussi o raggi.	GB To ensure the right tightening also with surfaces not perfectly flat, without spot-facing, concave convex and with different kinds of chamfers or radius.	DE Eine vollständige Abdichtung ist auch auf unebenen Flächen, wie geneigt, konkav oder konvex und mit unterschiedlichen Radien oder Fasen gewährleistet.
FR Pour permettre une parfaite étanchéité même sur des surfaces non planes, concaves, convexas ou inclinées et avec différents chanfreins ou rayons.	ES Consentir una completa estanqueidad incluso en superficies no perfectamente planas, cóncavas, convexas o inclinadas, con diferentes ángulos o radios.	PT Permite um aperto correto em superfícies não perfeitamente planas, cõncavas, convexas ou inclinadas, com diferentes chanfros ou raios.

Coppia di serraggio
Torque specifications
Angaben Drehmoment
Couple de serrage
Par de apriete
Especificações de Torque

UNF

"UNIVERSAL SHORT"
I valori di rottura possono variare in base all'articolo

*Breaking values may vary according to the item
Die maximal werte dienen nur zu Informationszwecken
Les valeurs maximales sont présentées à titre indicatif
Los valores de rotura pueden variar en función del artículo
Os valores de ruptura podem variar em função do item*

MISURA MEASURE GRÖSSE DIMENSIONS MEDIDA MEDIDA	COPPIA CONSIGLIATA Nm RECOMMENDED TORQUE Nm EMPFOHLENES DREHMOMENT Nm COUPLE DE SERRAGE Nm PAR ACONSEJADO Nm TORQUE RECOMENDADO Nm	COPPIA DI ROTTURA Nm BREAKING TORQUE Nm ABSCHERDREHMOMENT Nm COUPLE DE RUPTURE Nm PAR DE ROTURA Nm TORQUE DE RUPTURA Nm
10/32	0,8	3,2

MISURA MEASURE GRÖSSE DIMENSIONS MEDIDA MEDIDA	COPPIA MINIMA CONSIGLIATA Nm RECOMMENDED MINIMUM TORQUE Nm EMPFOHLENES DREHMOMENT Nm COUPLE DE SERRAGE Nm PAR MÍNIMO ACONSEJADO Nm TORQUE MÍNIMO RECOMENDADO Nm	COPPIA MASSIMA CONSIGLIATA Nm RECOMMENDED MAX TORQUE Nm ABSCHERDREHMOMENT Nm COUPLE DE RUPTURE Nm PAR MÁXIMO ACONSEJADO Nm TORQUE MÁXIMO RECOMENDADO Nm
1/8	5	7
1/4	5	7
3/8	5	7
1/2	5	7

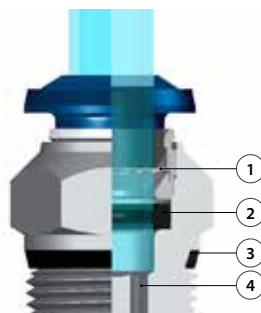
Vantaggi
IT

- 1 La pinza in acciaio inox garantisce il perfetto aggraffaggio di tubi di qualsiasi materiale senza danneggiarne la superficie.
Il collegamento tra tubo e raccordo assicura una tenuta totale anche in condizioni di urti e vibrazioni.
- 2 La particolare geometria della guarnizione permette inoltre l'utilizzo dei raccordi anche con il vuoto.
- 3 Tutte le filettature di questa serie sono state dotate di elementi di tenuta che permettono l'immediato utilizzo dei raccordi riducendo notevolmente i tempi di installazione.
- 4 Tutti i raccordi dritti possono essere montati anche con chiave esagonale ed è possibile utilizzarli anche in spazi molto ridotti.

Advantages
GB

- 1 The washer is made in stainless steel ensures the perfect tube clamping with every kinds of materials without damage the surface.
The connection between the tube and the fitting ensure a total tightness even in severe conditions such as impact and vibrations.
- 2 The particular geometric shape of the seal ensure the perfect tightness even with vacuum.
- 3 All of threads from this range have been equipped with tightening parts which allow the direct assembly of the fittings, reducing the installation time.
- 4 All the straight fittings can be assembled also with Allen wrench and it is possible to use them in reduced spaces.

Vorteile
DE

- 1 Konisches Gewinde "kurz" Die Zahnscheibe sorgt für eine perfekte Halterung des Rohres ohne die Oberfläche zu beschädigen. Die Dichtheit zwischen Rohr und Verschraubung ist auch bei Erschütterungen und Vibrationen gewährleistet.
- 2 Die besondere Geometrie der Dichtung ermöglicht auch die Anwendung der Verschraubungen in Verbindung mit Vakuum.
- 3 Alle Verschraubungen in dieser Serie sind mit Gewindeabdichtungen ausgestattet, die den sofortigen Einsatz ermöglichen und daher die Montagezeit stark reduzieren.
- 4 Alle geraden Verschraubungen können auch mit Inbusschlüsseln montiert werden, daher kleiner Lochabstand möglich.

Avantages
FR

- 1 La rondelle en acier inoxydable garantit la parfaite tenue du tube quelle que soit la matière et sans l'endommager.
La connexion entre le tube et le raccord assure une étanchéité totale même dans des conditions d'impact ou de vibrations.
- 2 La spécificité géométrique du joint permet l'utilisation des raccords avec le vide.
- 3 Tous les filetages de cette série sont équipés d'éléments d'étanchéité qui permettent l'utilisation immédiate des raccords réduisant ainsi le temps d'installation.
- 4 Tous les raccords droits peuvent être aussi montés avec une clé hexagonale pour permettre une utilisation dans des espaces réduits.

Ventajas
ES

- 1 La pinza en acero inoxidable garantiza el perfecto agarre del tubo de cualquier material sin perjudicar la superficie.
La conexión entre tubo y racor asegura una estanqueidad total aun en condiciones de impacto o vibración.
- 2 La particular geometría de la junta garantiza una perfecta estanqueidad incluso en vacío.
- 3 Todas las rosas de esta serie están fabricadas con junta de cierre que permite la inmediata utilización del racor reduciendo notablemente el tiempo de instalación.
- 4 Todos los racores rectos pueden montarse también con llave hexagonal y es posible utilizarlos incluso en espacios muy reducidos.

Vantagens
PT

- 1 A pinça em aço-inox garante o perfeito travamento do tubo de qualquer material sem danificar a superfície do mesmo. A conexão entre o tubo e a conexão assegura uma vedação total também em condições de impactos e vibrações.
- 2 A geometria particular da vedação permite a utilização da conexão também para aplicações com vácuo.
- 3 Todas as rosas desta série são dotadas de elementos de vedação, o que permite a imediata utilização das conexões, reduzindo notavelmente o tempo de instalação.
- 4 Todas as conexões retas podem ser montadas também com chave allentando possível montagem das mesmas em espaços bem reduzidos.

85000

RACCORDO DIRITTO MASCHIO "UNIVERSAL SHORT"

STRAIGHT MALE ADAPTOR "UNIVERSAL SHORT"
 GERADE EINSCHRAUBVERSCHRAUBUNG KONISCH "UNIVERSAL SHORT"
 RACCORD DROIT MÂLE, CONIQUE "UNIVERSAL SHORT"
 RACOR RECTO MACHO CÔNICO "UNIVERSAL SHORT"
 CONEXÃO RETA COM ROSCA "UNIVERSAL SHORT"

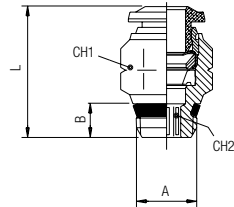

Code	Tube	A	B	L	CH1	CH2	Pack.
85000 00 001	1/8	1/8	5.5	16.5	11	2	10
85000 00 002	1/8	1/4	7	18.5	14	2	10
85000 00 003	5/32	1/8	5.5	18	11	3	10
85000 00 004	5/32	1/4	7	19	14	3	10
85000 00 005	1/4	1/8	5.5	21.5	13	4	10
85000 00 006	1/4	1/4	7	21	14	4	10
85000 00 007	1/4	3/8	7.5	23	17	4	10
85000 00 008	5/16	1/8	5.5	24.5	14	5	10
85000 00 009	5/16	1/4	7	22	14	6	10
85000 00 010	5/16	3/8	7.5	23	17	6	10
85000 00 011	3/8	1/8	5.5	28.5	17	5	10
85000 00 012	3/8	1/4	7	28.5	17	6	10
85000 00 013	3/8	3/8	7.5	26.5	17	6	10
85000 00 014	3/8	1/2	9	26.5	21	6	10
85000 00 018	1/2	1/8	5.5	33	20	5	10
85000 00 015	1/2	1/4	7	33	20	5	10
85000 00 016	1/2	3/8	7.5	32	20	9	10
85000 00 017	1/2	1/2	9	32	21	10	10

85020

RACCORDO DIRITTO MASCHIO

STRAIGHT MALE ADAPTOR
 GERADE EINSCHRAUBVERSCHRAUBUNG
 RACCORD DROIT MÂLE
 RACOR RECTO MACHO
 CONEXÃO RETA COM ROSCA

UNF

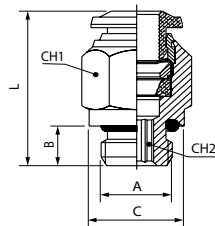

Code	Tube	A	B	L	CH	CH1	CH2	Pack.
85020 00 001	1/8	10/32	4	8	18	8	2	10
85020 00 002	5/32	10/32	4	8	21	10	2	10
85020 00 003	1/4	10/32	4	10	23.5	13	2	10

85030

RACCORDO DIRITTO FEMMINA

STRAIGHT FEMALE ADAPTOR
 AUFSCHRAUBVERSCHRAUBUNG
 RACCORD DROIT, FEMELLE
 RACOR RECTO HEMBRA
 CONEXÃO RETA COM ROSCA FÊMEA

NPTF

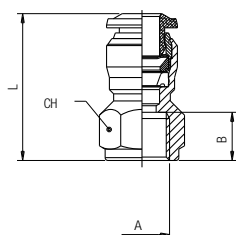

Code	Tube	A	B	L	CH	Pack.
85030 00 001	1/8	1/8	9.5	21	13	10
85030 00 002	1/8	1/4	13.5	29	16	10
85030 00 003	5/32	1/8	9.5	25	13	10
85030 00 004	5/32	1/4	13.5	30	16	10
85030 00 005	1/4	1/8	9.5	26	13	10
85030 00 006	1/4	1/4	13.5	29.5	16	10
85030 00 007	3/8	1/4	13.5	32.5	18	10
85030 00 008	3/8	3/8	13.5	32.5	20	10

85040

RACCORDO DIRITTO INTERMEDIO

STRAIGHT CONNECTOR
 VERBINDUNGSVERSCHRAUBUNG
 RACCORD UNION DOUBLE
 RACOR RECTO INTERMEDIO
 CONEXÃO RETA TUBO-TUBO

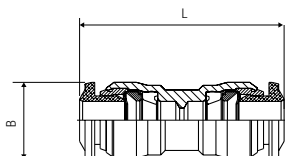

Code	Tube	Tube	L	B	Pack.
85040 00 001	1/8	1/8	28	10	10
85040 00 002	5/32	5/32	31	10	10
85040 00 004	1/4	5/32	34	12.5	10
85040 00 005	1/4	1/4	35	12.5	10
85040 00 014	5/16	5/32	37	14	10
85040 00 006	5/16	1/4	37	14	10
85040 00 007	5/16	5/16	37	14	10
85040 00 008	3/8	1/4	44	17	10
85040 00 009	3/8	5/16	44	17	10
85040 00 010	3/8	3/8	45	17	10
85040 00 013	1/2	5/16	50	20	10
85040 00 011	1/2	3/8	50	20	10
85040 00 012	1/2	1/2	50	20	10

85050

RACCORDO DIRITTO INTERMEDIO DI ATTRAVERSAMENTO

BULKHEAD CONNECTOR
 SCHOTTVERSCHRAUBUNG
 RACCORD TRAVERSÉE DE CLOISON
 RACOR RECTO INTERMEDIO PASATABIQUES
 CONEXÃO PASSA-MURO RETA TUBO-TUBO

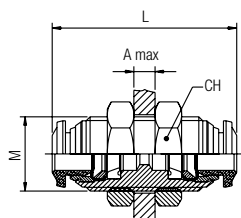

Code	Tube	M	L	CH	A max	Pack.
85050 00 001	1/8	M10X1	26	14	5	10
85050 00 002	5/32	M12X1	32	17	7	10
85050 00 003	1/4	M14X1	35	17	9.5	10
85050 00 004	5/16	M16X1	37.5	19	10.5	10
85050 00 005	3/8	M20X1	44	24	12.5	10
85050 00 006	1/2	M22X1	49	26	16.5	10

85111

RACCORDO A L ORIENTABILE MASCHIO "UNIVERSAL SHORT"

ORIENTING ELBOW MALE ADAPTOR "UNIVERSAL SHORT"
 WINKELVERSCHRAUBUNG KONISCH (DREHBAR) "UNIVERSAL SHORT"
 EQUERRE ORIENTABLE MÂLE, CONIQUE "UNIVERSAL SHORT"
 RACOR A L ORIENTABLE MACHO CÓNICO "UNIVERSAL SHORT"
 CONEXÃO MACHO EM "L" ORIENTÁVEL COM ROSCA "UNIVERSAL SHORT"

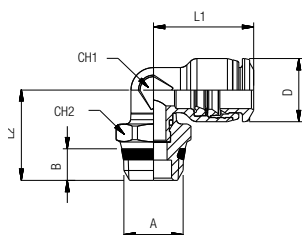

Code	Tube	A	B	L1	L2	CH1	CH2	D	Pack.
85111 00 001	1/8	1/8	5.5	15	15.5	7	13	10	10
85111 00 002	1/8	1/4	7	15	18	7	15	10	10
85111 00 003	5/32	1/8	5.5	16.5	15.5	7	13	10	10
85111 00 004	5/32	1/4	7	16.5	18	7	15	10	10
85111 00 006	1/4	1/8	5.5	20.5	17.5	9	13	12.5	10
85111 00 007	1/4	1/4	7	20.5	19	9	15	12.5	10
85111 00 008	1/4	3/8	7.5	20.5	20	9	17	12.5	10
85111 00 009	1/4	1/2	9	20.5	22	9	21	12.5	10
85111 00 010	5/16	1/8	5.5	22	18.5	10	13	14	10
85111 00 011	5/16	1/4	7	22	20	10	15	14	10
85111 00 012	5/16	3/8	7.5	22	20.5	10	17	14	10
85111 00 013	5/16	1/2	9	22	23	10	21	14	10
85111 00 014	3/8	1/4	7	26.5	22	13	16	17	10
85111 00 015	3/8	3/8	7.5	26.5	22	13	17	17	10
85111 00 016	3/8	1/2	9	26.5	24.5	13	21	17	10
85111 00 017	1/2	1/4	7	30	23	16	16	20	10
85111 00 018	1/2	3/8	7.5	30	23	16	17	20	10
85111 00 019	1/2	1/2	9	30	25.5	16	21	20	10

85116

UNF

RACCORDO A L ORIENTABILE MASCHIO CILINDRICO

ORIENTING ELBOW MALE ADAPTOR (PARALLEL)
 WINKELVERSCHRAUBUNG ZYLINDRISCH (DREHBAR)
 EQUERRE ORIENTABLE MÂLE, CYLINDRIQUE
 RACOR A L ORIENTABLE MACHO CILÍNDRICO CON TÓRICA
 CONEXÃO MACHO EM "L" ORIENTÁVEL COM ROSCA PARALELA

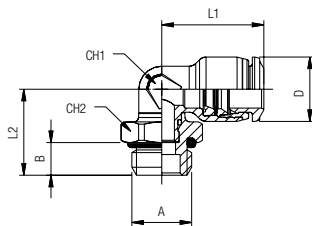

Code	Tube	A	B	L1	L2	CH1	CH2	D	Pack.
85116 00 001	5/32	10/32	4	16.5	14.5	7	9	10	10
85116 00 002	1/4	10/32	4	20.5	15.5	9	9	12.5	10

85130

RACCORDO A L INTERMEDIO

ELBOW CONNECTOR
 WINKELVERSCHRAUBUNG
 RACCORD EQUERRE
 RACOR A L INTERMEDIO
 CONEXÃO EM "L" TUBO-TUBO

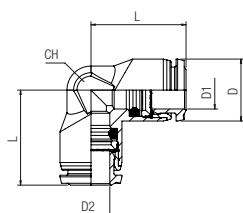

Code	D1	D2	L	D	CH	Pack.
85130 00 001	1/8	1/8	15.5	10	9	10
85130 00 002	5/32	5/32	16.5	10	9	10
85130 00 004	1/4	1/4	20.5	12.5	11	10
85130 00 009	5/16	1/4	22.5	14	13	10
85130 00 005	5/16	5/16	22	14	13	10
85130 00 012	3/8	1/4	26	17	16	10
85130 00 010	3/8	5/16	26	17	16	10
85130 00 006	3/8	3/8	26.5	17	16	10
85130 00 011	1/2	3/8	30.5	20	19	10
85130 00 007	1/2	1/2	30.5	20	19	10

85140

RACCORDO A L CON CODA LISCIA CORTA

ORIENTING ELBOW
 WINKELSTECKVERSCHRAUBUNG KURZ
 RACCORD EQUERRE ENCLIQUETABLE
 RACOR A L ORIENTABLE CON ESPIGA LISA CORTA
 CONEXÃO EM "L" COM PONTA LISA E CURTA

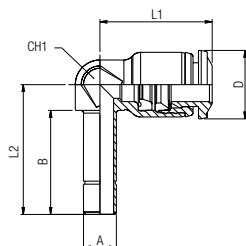

Code	Tube	A	B	L1	L2	CH1	D	Pack.
85140 00 001	5/32	5/32	17	16.5	20.8	7	10	10
85140 00 002	5/32	1/4	19	16.5	22.8	7	10	10
85140 00 006	1/4	5/32	17	20.5	21.7	9	12.5	10
85140 00 005	1/4	1/4	19	20.5	23.7	9	12.5	10
85140 00 012	1/4	5/16	20	22.5	26	10	14	10
85140 00 007	5/16	5/16	20	22	26	10	14	10
85140 00 008	5/16	3/8	21.8	22	27.6	10	14	10
85140 00 009	3/8	3/8	22.5	26.5	30	13	17	10
85140 00 010	3/8	1/2	24.7	26.5	32.2	13	17	10
85140 00 011	1/2	1/2	25.5	30	33.5	16	20	10

85150

RACCORDO A L CON CODA LISCIA LUNGA

ORIENTING ELBOW

WINKELSTECKVERSCHRAUBUNG LANG

RACCORD EQUERRE ENCLIQUETABLE, RALLONGÉ

RACOR A L ORIENTABLE CON ESPIGA LISA LARGA

CONEXÃO EM "L" COM PONTA LISA E LONGA

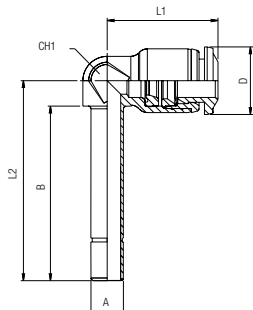

Code	Tube	A	B	L1	L2	CH1	D	Pack.
85150 00 001	5/32	5/32	28	16.5	31.8	7	10	10
85150 00 002	5/32	1/4	30.5	16.5	34.3	7	10	10
85150 00 006	1/4	5/32	30	20.5	34.7	9	12.5	10
85150 00 005	1/4	1/4	32.3	20.5	37	9	12.5	10
85150 00 007	5/16	5/16	36	22	42	10	14	10
85150 00 008	5/16	3/8	37.5	22	43.1	10	14	10
85150 00 009	3/8	3/8	40.8	26.5	48.3	13	17	10
85150 00 010	3/8	1/2	43.2	26.5	50.7	13	17	10
85150 00 011	1/2	1/2	47	31	55	16	20	10

85160

RACCORDO A 45° CON CODA LISCIA CORTA

45° ORIENTING ELBOW

WINKELSTECKVERSCHRAUBUNG 45°

RACCORD EQUERRE ENCLIQUETABLE À 45°

RACOR A 45° CON ESPIGA LISA CORTA

CONEXÃO A 45° COM PONTA LISA CURTA

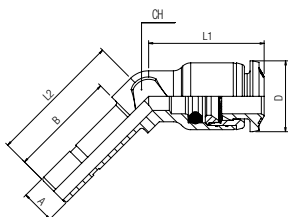

Code	Tube	A	B	L1	L2	CH1	D	Pack.
85160 00 002	5/32	5/32	17	12.5	21	7	10	10
85160 00 004	1/4	1/4	19	20.5	23.5	9	12	10
85160 00 005	5/16	5/16	20	22	25	10	14	10
85160 00 006	3/8	3/8	22.5	26.5	30	13	17	10
85160 00 007	1/2	1/2	25.5	30	33.5	16	20	10

85170

RACCORDO ORIENTABILE A 45° MASCHIO "UNIVERSAL SHORT"

45° ORIENTING ELBOW MALE ADAPTOR "UNIVERSAL SHORT"

WINKELVERSCHRAUBUNG 45° KONISCH (DREHBAR) "UNIVERSAL SHORT"

EQUERRE À 45° ORIENTABLE MÂLE, CONIQUE "UNIVERSAL SHORT"

RACOR A 45° ORIENTABLE MACHO "UNIVERSAL SHORT"

CONEXÃO ORIENTÁVEL A 45° ROSCA MACHO "UNIVERSAL SHORT"

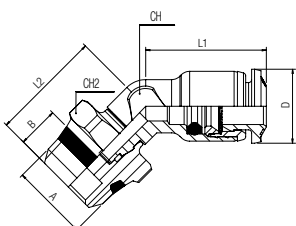

Code	Tube	A	B	L1	L2	CH1	CH2	D	Pack.
85170 00 001	5/32	1/8	5.5	12.5	16.5	7	13	10	10
85170 00 006	1/4	1/8	5.5	20.5	17.5	9	13	12	10
85170 00 007	1/4	1/4	7	20.5	18.9	9	15	12	10
85170 00 008	5/16	1/8	5.5	22	18.5	10	13	14	10
85170 00 009	5/16	1/4	7	22	20	10	15	14	10
85170 00 010	5/16	3/8	7.5	22	20.5	10	17	14	10
85170 00 014	3/8	1/4	7	26.5	21.8	13	16	17	10
85170 00 015	3/8	3/8	7.5	26.5	21.8	13	17	17	10
85170 00 016	3/8	1/2	9	26.5	24.3	13	21	17	10
85170 00 017	1/2	1/4	7	30	23.1	16	16	20	10
85170 00 018	1/2	3/8	7.5	30	23.1	16	17	20	10
85170 00 019	1/2	1/2	9	30	25.6	16	21	20	10

85180

RACCORDO INTERMEDIO A 45°

45° ELBOW CONNECTOR
 WINKELVERSCHRAUBUNG 45°
 RACCORD EQUERRE À 45°
 RACOR INTERMEDIO 45°
 CONEXÃO INTERMEDIÁRIA A 45°

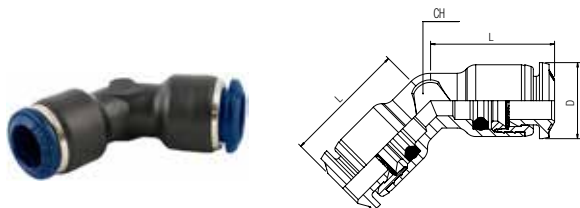

Code	Tube	L	CH	D	Pack.
85180 00 002	5/32	16.5	7	10	10
85180 00 004	1/4	20.5	9	12	10
85180 00 005	5/16	22	10	14	10
85180 00 006	3/8	26.5	13	17	10
85180 00 007	1/2	30	16	20	10

85211

RACCORDO A T ORIENTABILE MASCHIO "UNIVERSAL SHORT"

ORIENTING TEE MALE ADAPTOR "UNIVERSAL SHORT" - CENTRE LEG
 T-EINSCHRAUBVERSCHRAUBUNG KONISCH (DREHBAR) "UNIVERSAL SHORT"
 TÉ ORIENTABLE À PIQUAGE MÂLE CENTRAL, CONIQUE "UNIVERSAL SHORT"
 RACOR A T ORIENTABLE MACHO CENTRAL CÓNICO "UNIVERSAL SHORT"
 CONEXÃO EM "T" CENTRAL ORIENTÁVEL COM ROSCA MACHO "UNIVERSAL SHORT"

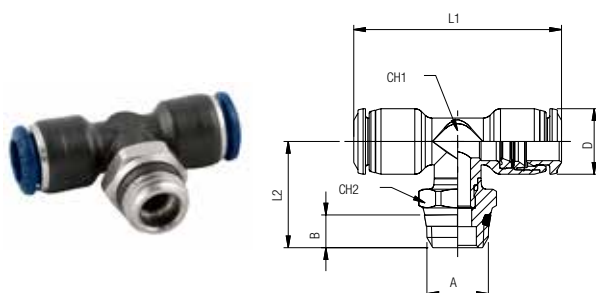

Code	Tube	A	B	L1	L2	CH1	CH2	D	Pack.
85211 00 001	1/8	1/8	5.5	30.5	18.5	7	13	10	10
85211 00 002	1/8	1/4	7	30.5	20	7	15	10	10
85211 00 003	5/32	1/8	5.5	33	18.5	7	13	10	10
85211 00 004	5/32	1/4	7	33	20	7	15	10	10
85211 00 006	1/4	1/8	5.5	41	20	9	13	12.5	10
85211 00 007	1/4	1/4	7	41	21.5	9	15	12.5	10
85211 00 008	5/16	1/8	5.5	44	21	10	13	14	10
85211 00 009	5/16	1/4	7	44	22.5	10	15	14	10
85211 00 010	5/16	3/8	7.5	44	23	10	17	14	10
85211 00 011	3/8	1/4	7	53	25.5	13	16	17	10
85211 00 012	3/8	3/8	7.5	53	25.5	13	17	17	10
85211 00 013	3/8	1/2	9	53	28	13	21	17	10
85211 00 014	1/2	1/4	7	60	27	16	16	20	10
85211 00 015	1/2	3/8	7.5	60	27	16	17	20	10
85211 00 016	1/2	1/2	9	60	29.5	16	21	20	10

85216

RACCORDO A T ORIENTABILE MASCHIO CILINDRICO

ORIENTING TEE MALE ADAPTOR (PARALLEL) - CENTRE LEG
 T-EINSCHRAUBVERSCHRAUBUNG ZYLINDRISCH (DREHBAR)
 TÉ ORIENTABLE À PIQUAGE MÂLE CENTRAL, CYLINDRIQUE
 RACOR A T ORIENTABLE MACHO CENTRAL CILÍNDRICO CON TÓRICA
 CONEXÃO MACHO EM "T" ORIENTÁVEL COM ROSCA PARALELA

UNF

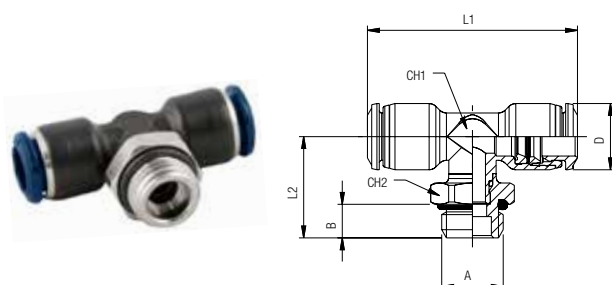

Code	Tube	A	B	L1	L2	CH1	CH2	D	Pack.
85216 00 001	5/32	10/32	4	30.5	16	7	9	10	10
85216 00 002	1/4	10/32	4	40.5	15.5	9	9	12.5	10

85223

RACCORDO A T ORIENTABILE MASCHIO LATERALE "UNIVERSAL SHORT"

ORIENTING TEE MALE ADAPTOR "UNIVERSAL SHORT" OFF - SET LEG
 L-EINSCHRAUBVERSCHRAUBUNG KONISCH (DREHBAR) "UNIVERSAL SHORT"
 TÉ ORIENTABLE À PIQUAGE LATÉRAL, CONIQUE "UNIVERSAL SHORT"
 RACOR A T ORIENTABLE MACHO LATERAL CÓNICO "UNIVERSAL SHORT"
 CONEXÃO EM "T" LATERAL ORIENTÁVEL COM ROSCA MACHO "UNIVERSAL SHORT"

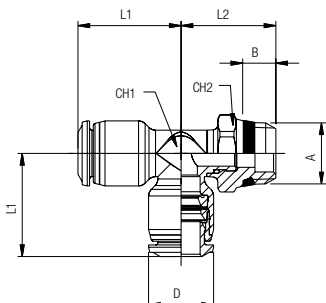

Code	Tube	A	B	L1	L2	CH1	CH2	D	Pack.
85223 00 001	1/8	1/8	5.5	15	18	7	13	10	10
85223 00 002	1/8	1/4	7	15	19.5	7	15	10	10
85223 00 003	5/32	1/8	5.5	16.5	18	7	13	10	10
85223 00 004	5/32	1/4	7	16.5	19.5	7	15	10	10
85223 00 006	1/4	1/8	5.5	20.5	17.5	9	13	12.5	10
85223 00 007	1/4	1/4	7	20.5	19	9	15	12.5	10
85223 00 008	5/16	1/8	5.5	22	19	10	13	14	10
85223 00 009	5/16	1/4	7	22	20.5	10	15	14	10
85223 00 010	5/16	3/8	7.5	22	21	10	17	14	10
85223 00 011	3/8	1/4	7	26.5	22	13	16	17	10
85223 00 012	3/8	3/8	7.5	26.5	22	13	17	17	10
85223 00 013	3/8	1/2	9	26.5	24.5	13	21	17	10
85223 00 014	1/2	1/4	7	31	23	16	16	20	10
85223 00 015	1/2	3/8	7.5	31	23	16	17	20	10
85223 00 016	1/2	1/2	9	31	25.5	16	21	20	10

85226

UNF

RACCORDO A T ORIENTABILE MASCHIO LATERALE CILINDRICO

ORIENTING TEE MALE ADAPTOR (PARALLEL) - OFF - SET LEG
 L-EINSCHRAUBVERSCHRAUBUNG ZYLINDRISCH (DREHBAR)
 TÉ ORIENTABLE À PIQUAGE LATÉRAL, CYLINDRIQUE
 RACOR A T ORIENTABLE MACHO LATERAL CILÍNDRICO CON TÓRICA
 CONEXÃO MACHO EM "T" LATERAL ORIENTÁVEL COM ROSCA PARALELA

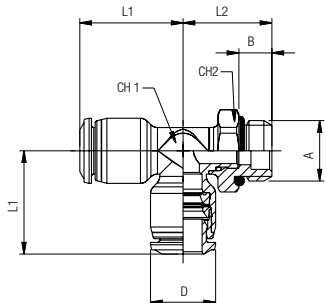

Code	Tube	A	B	L1	L2	CH1	CH2	D	Pack.
85226 00 001	5/32	10/32	4	16.5	16	7	9	10	10
85226 00 002	1/4	10/32	4	20.5	14.5	9	9	12.5	10

85230

RACCORDO A T INTERMEDIO

TEE CONNECTOR
 T-ANSCHLUSS
 RACCORD TÉ
 RACOR A T INTERMEDIO
 CONEXÃO EM "T" TUBO-TUBO

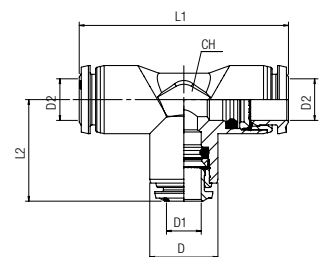

Code	Tube	L1	L2	CH	D	D1	D2	Pack.
85230 00 001	1/8	31	15.5	9	10	3	3	10
85230 00 002	5/32	33	16.5	9	10	4	4	10
85230 00 019	5/32-1/4-5/32	40	20.5	11	12.5	6	4	10
85230 00 009	1/4-5/32-1/4	41	20	11	12.5	4	6	10
85230 00 004	1/4	41	20.5	11	12.5	6	6	10
85230 00 010	5/16-1/4-5/16	45	22.5	13	14	6	8	10
85230 00 005	5/16	44	22	13	14	8	8	10
85230 00 015	5/16-3/8-5/16	52	26.5	16	17	10	8	10
85230 00 011	3/8-5/16-3/8	53	26	16	17	8	10	10
85230 00 006	3/8	53	26.5	16	17	10	10	10
85230 00 017	3/8-1/2-3/8	59.5	30.5	19	20	12	10	10
85230 00 012	1/2-3/8-1/2	61.5	30	19	20	10	12	10
85230 00 007	1/2	61.5	30	19	20	12	12	10

85240

RACCORDO A T ORIENTABILE CON CODA LISCIA CURTA

ORIENTING TEE

T-STECKANSCHLUSS

RACCORD TÉ ENCLIQUETABLE

RACOR A T ORIENTABLE CON ESPIGA LISA CORTA

CONEXÃO EM "T" COM PONTA LISA E CURTA

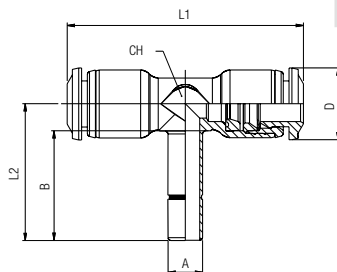

Code	Tube	A	B	L1	L2	CH	D	Pack.
85240 00 001	5/32	5/32	17	33	20.7	7	10	10
85240 00 002	5/32	1/4	19	33	22.7	7	10	10
85240 00 006	1/4	5/32	17	41	21.7	9	12.5	10
85240 00 005	1/4	1/4	19	41	23.7	9	12.5	10
85240 00 007	5/16	5/16	20	44	26	10	14	10
85240 00 008	5/16	3/8	22.2	44	28	10	14	10
85240 00 009	3/8	3/8	22.5	53	30	13	17	10
85240 00 010	3/8	1/2	25	53	32.2	13	17	10
85240 00 011	1/2	1/2	25.5	61.5	33.5	16	20	10

85310

RACCORDO A Y INTERMEDIO

Y CONNECTOR

Y-ANSCHLUSS

RACCORD Y SIMPLE

RACOR A Y INTERMEDIO

CONEXÃO EM "Y" TUBO-TUBO

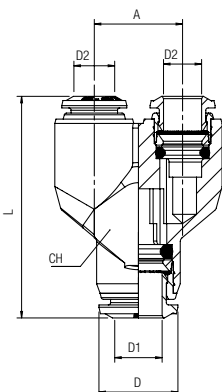

Code	D1	D2	A	L	CH	D	Pack.
85310 00 002	5/32	5/32	11	31.5	10	10	10
85310 00 008	1/4	5/32	13.5	36.5	12	12.5	10
85310 00 004	1/4	1/4	13.5	37	12	12.5	10
85310 00 009	5/16	1/4	15.5	41	14	14	10
85310 00 005	5/16	5/16	15.5	40	14	14	10
85310 00 006	3/8	3/8	19	48.5	17	18	10
85310 00 011	1/2	5/16	22	57.5	20	20	10
85310 00 007	1/2	1/2	22	59	20	20	10

85320

RACCORDO A Y ORIENTABILE MASCHIO "UNIVERSAL SHORT"

ORIENTING Y MALE ADAPTOR "UNIVERSAL SHORT"

Y-EINSCHRAUBVERSCHRAUBUNG KONISCH (DREHBAR) "UNIVERSAL SHORT"

Y SIMPLE ORIENTABLE MÂLE, CONIQUE "UNIVERSAL SHORT"

RACOR A Y ORIENTABLE MACHO CÓNICO "UNIVERSAL SHORT"

CONEXÃO MACHO EM "Y" ORIENTÁVEL COM ROSCA "UNIVERSAL SHORT"

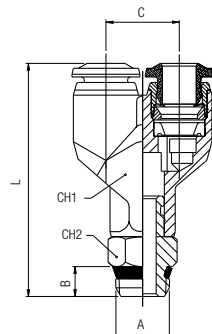

Code	Tube	A	B	C	L	CH1	CH2	Pack.
85320 00 001	5/32	1/8	5.5	11	38	10	11	10
85320 00 002	5/32	1/4	7	11	40.5	10	14	10
85320 00 003	1/4	1/8	5.5	13.5	43	12	11	10
85320 00 004	1/4	1/4	7	13.5	45.5	12	14	10
85320 00 005	5/16	1/8	5.5	15.5	46.5	14	11	10
85320 00 006	5/16	1/4	7	15.5	49	14	14	10
85320 00 007	5/16	3/8	7.5	15.5	49.5	14	17	10
85320 00 008	3/8	1/4	7	19	56.5	17	14	10
85320 00 009	3/8	3/8	7.5	19	57.5	17	17	10
85320 00 010	3/8	1/2	9	19	60	17	21	10
85320 00 011	1/2	3/8	7.5	22	66.5	20	17	10
85320 00 012	1/2	1/2	9	22	68	20	21	10

85325

UNF

RACCORDO A Y ORIENTABILE MASCHIO CILINDRICO

ORIENTING Y MALE ADAPTOR (PARALLEL)

Y-EINSCHRAUBVERSCHRAUBUNG ZYLINDRISCH (DREHBAR)

Y SIMPLE ORIENTABLE MÂLE, CYLINDRIQUE

RACOR A Y ORIENTABLE MACHO CILÍNDRICO CON TÓRICA

CONEXÃO MACHO EM "Y" ORIENTÁVEL COM ROSCA PARALELA

Code	Tube	A	B	C	L	CH1	CH2	Pack.
85325 00 001	5/32	10/32	4	11	36.5	10	10	10
85325 00 002	1/4	10/32	4	13.5	41.5	12	10	10

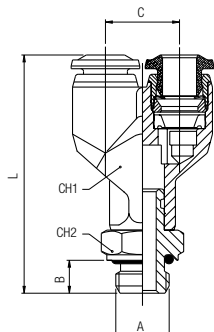

85330

RACCORDO MULTIPLO A Y INTERMEDIO

Y CONNECTOR MANIFOLD

Y-4 FACH-VERTEILER

RACCORD Y DOUBLE

RACOR A Y MÚLTIPLE INTERMEDIO

CONEXÃO EM "Y" TUBO-TUBO COM 4 SAÍDAS

Code	D1	D2	C	L	F	H	Pack.
85330 00 002	5/32	5/32	11	33.5	3.3	21.5	10
85330 00 001	5/32	1/4	11	34.5	3.3	21.5	10
85330 00 003	1/4	1/4	13.5	39.5	3.3	26.8	10
85330 00 004	1/4	5/16	13.5	40	3.3	26.8	10

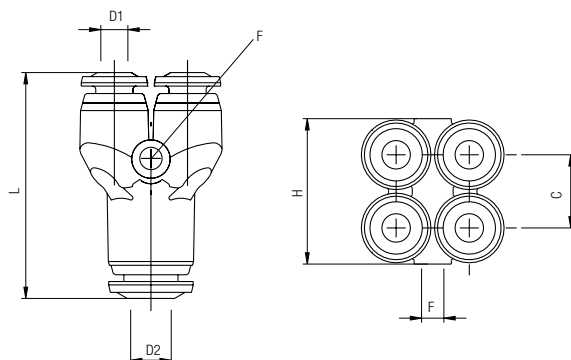

85340

RACCORDO MULTIPLO A Y ORIENTABILE MASCHIO "UNIVERSAL SHORT"

Y CONNECTOR ORIENTING MALE ADAPTOR "UNIVERSAL SHORT"

Y-4 FACH-EINSCHRAUBVERSCHRAUBUNG KONISCH (DREHBAR) "UNIVERSAL SHORT"

Y DOUBLE ORIENTABLE MÂLE, CONIQUE "UNIVERSAL SHORT"

RACOR A Y MÚLTIPLE ORIENTABLE MACHO CÓNICO "UNIVERSAL SHORT"

CONEXÃO MACHO EM "Y" ORIENTÁVEL COM 4 SAÍDAS E ROSCA "UNIVERSAL SHORT"

Code	Tube	A	B	C	L	H	CH	F	Pack.
85340 00 001	5/32	1/8	5.5	11	39.5	21.5	11	3.3	10
85340 00 002	5/32	1/4	7	11	42	21.5	14	3.3	10
85340 00 003	1/4	1/8	5.5	13.5	46.5	26.8	11	3.3	10
85340 00 004	1/4	1/4	7	13.5	48	26.8	14	3.3	10

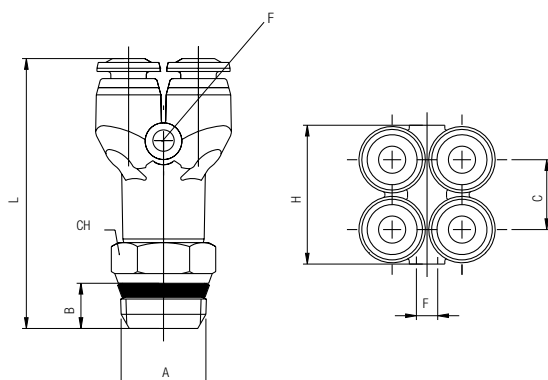

85350

RACCORDO MULTIPLO DI RIDUZIONE

REDUCTION MANIFOLD
 T-MEHRFACHVERTEILER REDUZIERT
 MULTI-TÉ RÉDUIT
 RACOR DISTRIBUIDOR MÚLTIPLE DE REDUCCIÓN
 CONEXÃO DE REDUÇÃO MÚLTIPLA

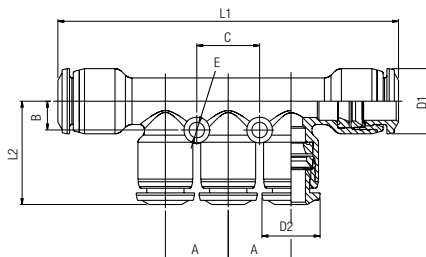

Code	Tube	A	B	L1	L2	C	D1	D2	E	Pack.
85350 00 002	1/4-5/32	13.5	6	74	22	13.5	14	12	3.3	10
85350 00 001	5/16-5/32	13.5	6	73	22	13.5	14	12	3.3	10
85350 00 003	5/16-1/4	13.5	6	73	22.5	13.5	14	12.5	3.3	10
85350 00 004	3/8-1/4	15	7	83	24	15	17	14	3.3	10
85350 00 005	3/8-5/16	15	7	83	23	15	17	14	3.3	10

85360

RACCORDO MULTIPLO DI RIDUZIONE ORIENTABILE MASCHIO "UNIVERSAL SHORT"

REDUCTION MANIFOLD ORIENTING MALE ADAPTOR "UNIVERSAL SHORT"
 T-MEHRFACHVERSCHRAUBUNG REDUZIERT KONISCH (DREHBAR) "UNIVERSAL SHORT"
 MULTI-TÉ RÉDUIT, PIQUAGE LATÉRAL, CONIQUE "UNIVERSAL SHORT"
 RACOR DISTRIBUIDOR MÚLTIPLE DE REDUCCIÓN ORIENTABLE MACHO CÓNICO "UNIVERSAL SHORT"
 CONEXÃO MACHO DE REDUÇÃO MÚLTIPLA COM ROSCA "UNIVERSAL SHORT"

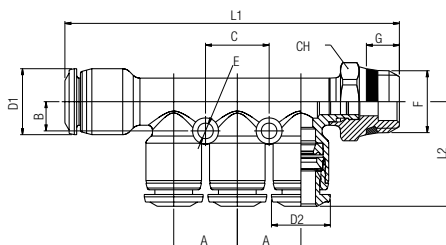

Code	Tube	F	A	B	L1	L2	C	D1	D2	E	G	H	Pack.
85360 00 003	1/4-5/32	1/8	13.5	6	70	22	13.5	14	12	3.3	5.5	13	10
85360 00 004	1/4-5/32	1/4	13.5	6	71.4	22	13.5	14	12	3.3	7	15	10
85360 00 001	5/16-5/32	1/8	13.5	6	70	22	13.5	14	12	3.3	5.5	13	10
85360 00 002	5/16-5/32	1/4	13.5	6	71.4	22	13.5	14	12	3.3	7	15	10
85360 00 005	5/16-1/4	1/8	13.5	6	70	22	13.5	14	12.5	3.3	5.5	13	10
85360 00 006	5/16-1/4	1/4	13.5	6	71.4	22	13.5	14	12.5	3.3	7	15	10
85360 00 007	3/8-1/4	1/4	15	7	81.5	24	15	17	14	3.3	7	16	10
85360 00 008	3/8-1/4	3/8	15	7	81.5	24	15	17	14	3.3	7.5	17	10
85360 00 009	3/8-5/16	1/4	15	7	81.5	23	15	17	14	3.3	7	16	10
85360 00 010	3/8-5/16	3/8	15	7	81.5	23	15	17	14	3.3	7.5	17	10

85500

ANELLO ORIENTABILE A L

SINGLE BANJO BODY
 RINGANSCHLUSS
 CORPS SIMPLE POUR BANJO
 ANILLO ORIENTABLE SIMPLE
 ANEL ORIENTÁVEL EM "L"

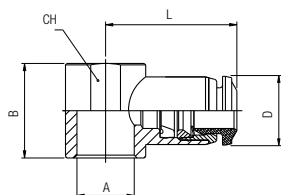

Code	Tube	A	B	L	CH	D	Pack.
85500 00 019	1/8	M6	14	20.5	9	10	10
85500 00 001	1/8	1/8	16.5	20.5	14	10	10
85500 00 002	5/32	M5	14	19.5	9	10	10
85500 00 003	5/32	M6	14	19.5	9	10	10
85500 00 004	5/32	1/8	16.5	21.5	14	10	10
85500 00 005	5/32	1/4	18.5	23.5	18	10	10
85500 00 021	1/4	M5	14	21	9	12	10
85500 00 010	1/4	M6	14	21	9	12	10
85500 00 011	1/4	1/8	16.5	23	14	12	10
85500 00 012	1/4	1/4	18.5	25.5	18	12	10
85500 00 013	5/16	1/8	16.5	23.5	14	14	10
85500 00 014	5/16	1/4	18.5	26	18	14	10
85500 00 015	5/16	3/8	22	27.5	21	14	10
85500 00 020	3/8	1/4	18.5	31	18	17	10
85500 00 016	3/8	3/8	22	30.5	21	17	10
85500 00 017	1/2	3/8	22	32.5	21	20	10
85500 00 018	1/2	1/2	26	35	26	20	10

85510

ANELLO ORIENTABILE A T
 DOUBLE BANJO BODY
 DOPPELTER RINGANSCHLUSS
 CORPS DOUBLE POUR BANJO
 ANILLO ORIENTABLE DOBLE
 ANEL ORIENTÁVEL EM "T"

Code	Tube	A	B	L	CH	D	Pack.
85510 00 008	5/32	M5	14	39	9	10	10
85510 00 001	5/32	1/8	16.5	43	14	10	10
85510 00 006	1/4	1/8	16.5	46	14	12	10
85510 00 007	1/4	1/4	18.5	51	18	12	10
85510 00 004	5/16	1/8	16.5	47	14	14	10
85510 00 005	5/16	1/4	18.5	52	18	14	10

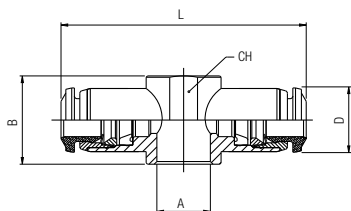

85520

ANELLO ORIENTABILE A Y
 DOUBLE BANJO BODY
 DOPPELTER RINGANSCHLUSS
 CORPS DOUBLE POUR BANJO
 ANILLO ORIENTABLE DOBLE
 ANEL ORIENTÁVEL EM "Y"

Code	Tube	A	B	C	L	D	Pack.
85520 00 001	5/32	1/8	16.5	13	21	12	10
85520 00 002	5/32	1/4	18.5	15.5	24	14	10
85520 00 003	1/4	1/8	16.5	13	21.5	12.5	10
85520 00 004	1/4	1/4	18.5	15.5	24.5	14	10
85520 00 005	1/4	3/8	22	13.5	25	12.5	10
85520 00 006	5/16	1/4	18.5	15.5	24.5	14	10
85520 00 007	5/16	3/8	22	19	28	17	10
85520 00 008	3/8	3/8	22	19	28	17	10

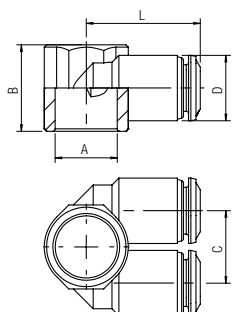

55410

VITE CAVA SINGOLA
 BANJO STEM SINGLE
 EINFACHE HOHLSCHRAUBE
 VIS POUR BANJO SIMPLE
 TORNILLO SIMPLE
 HASTE PARA CONEXÃO BANJO COM 1 CAVIDADE

ISO 228
ISO R/262

Code	A	L	CH	Pack.
55410 00 01 B5 NB	M5	22	8	10
55410 00 01 B8 NB	M6	23	8	10
55410 00 01 02 NB	1/8	28	14	10
55410 00 01 03 NB	1/4	32	17	10
55410 00 01 04 NT	3/8	36	19	10
55410 00 01 05 NT	1/2	42	24	10

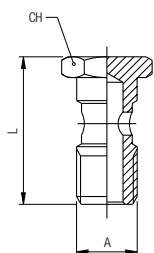

55420

VITE CAVA DOPPIA
 BANJO STEM DOUBLE
 DOPPELTE HOHLSCHRAUBE
 VIS DOUBLE POUR BANJO
 TORNILLO DOBLE
 HASTE PARA CONEXÃO BANJO COM 2 CAVIDADES

ISO 228
ISO R/262

Code	A	L	CH	Pack.
55420 00 01 02 NT	1/8	44.5	14	10
55420 00 01 03 NT	1/4	50.5	17	10
55420 00 01 04 NT	3/8	58	19	10
55420 00 01 05 NT	1/2	68	24	10

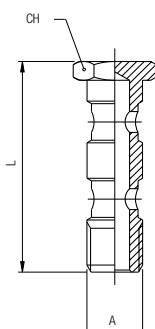

55430

VITE CAVA TRIPLA

BANJO STEM TRIPLE
 DREIFACH HOHLSCHRAUBE
 VIS TRIPLE POUR BANJO
 TORNILLO TRIPLE
 HASTE PARA CONEXÃO BANJO COM 3 CAVIDADES



ISO 228

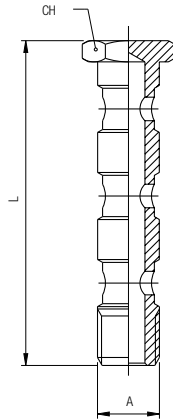

Code	A	L	CH	Pack.
55430 00 01 02 NT	1/8	61	14	10
55430 00 01 03 NT	1/4	69	17	10
55430 00 01 04 NT	3/8	80	19	10
55430 00 01 05 NT	1/2	94	24	10

55440

VITE CAVA SINGOLA MASCHIO - FEMMINA

MALE - FEMALE BANJO STEM SINGLE
 AUFSCHRAUBHOHLSCHRAUBE MIT INNENGEWINDE
 VIS SIMPLE CREUSE TARAUDÉE POUR BANJO
 TORNILLO SIMPLE MACHO - HEMBRA
 HASTE PARA CONEXÃO BANJO COM 1 CAVIDADE MACHO - FÊMEA



ISO 228

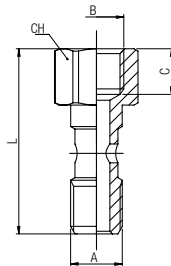

Code	A	B	C	L	CH	Pack.
55440 00 01 02 NB	1/8	1/8	8.5	34.5	14	10
55440 00 01 03 NB	1/4	1/4	11	40.5	17	10
55440 00 01 04 NB	3/8	3/8	12	45.5	19	10

82241

ADATTATORE FEMMINA CILINDRICO - MASCHIO NPTF

ADAPTER FEMALE BSP - MALE NPTF
 GEWINDESTUTZEN IG BSP - AG NPTF
 ADAPTATEUR FEMELLE BSP- MÂLE NPTF
 ADAPTADOR HEMBRA CILÍNDRICO BSP - MACHO NPTF
 ADAPTADOR FÊMEA COM ROSCA PARALELA BSP - MACHO NPTF

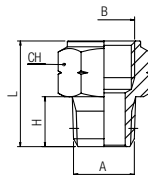

Code	A (NPTF)	B (BSPP)	H	L	CH	Pack.
82241 00 01 8K NB	10/32 UNF	M5	4.5	12	8	10
82241 00 01 2W NB	1/8	1/8	8.5	19.5	14	10
82241 00 01 6W NB	1/4	1/4	13	27	17	10
82241 00 01 AB NB	3/8	3/8	13	28	22	10

ESEMPI DI ASSEMBLAGGIO DELLE VITI CON ANELLI ORIENTABILI SINGOLI E DOPPI.

ASSEMBLING EXAMPLES OF VARIOUS BANJO STEMS WITH SINGLE AND DOUBLE BANJO BODIES.

MONTAGEBEISPIELE VON HOHLSCHRAUBEN MONTIERT MIT EINFACHEN- UND DOPPELTEN RINGANSCHLÜSSEN.

EXEMPLES D'ASSEMBLAGES DES CORPS SIMPLES ET DOUBLES.

EJEMPLO DE MONTAJE DEL TORNILLO CON EL ANILLO ORIENTABLE SIMPLE Y DOBLE.

EXEMPLOS DE MONTAGEM DOS BANJOS COM ANÉIS ORIENTÁVEIS SIMPLES E DUPLOS.



Vite cava singola
Banjo stem single
Einfache hohlschraube
Vis pour banjo simple
Tornillo simple
Haste p/ banjo c/ 1 cavidade

Vite cava doppia
Banjo stem double
Doppelte hohlschraube
Vis double pour banjo
Tornillo doble
Haste p/ banjo c/ 2 cavidades

Vite cava tripla
Banjo stem triple
Dreifache hohlschraube
Vis triple pour banjo
Tornillo triple
Haste p/banjo c/ 3 cavidades

88610

TAPPO IN POLIAMIDE

POLYAMIDE PLUG
VERSCHLUSSZAPFEN POLYAMID
BOUCHON EN POLYAMIDE
TAPÓN EN POLIAMIDA
TAMPÃO EM POLIAMIDA

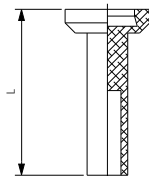

Code	Tube	L	Pack.
88610 00 31 02 NE	1/8	18	10
88610 00 31 27 NE	5/32	23.5	10
88610 00 31 03 NE	1/4	24.5	10
88610 00 31 28 NE	5/16	26	10
88610 00 31 04 NE	3/8	28.5	10
88610 00 31 05 NE	1/2	28.5	10

85620

TAPPO TERMINALE

TERMINAL PLUG
VERSCHLUSSKAPPEN
BOUCHON TERMINAL
TAPÓN TERMINAL
TAMPA FINAL

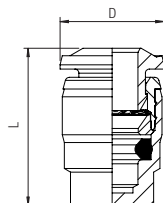

Code	Tube	D	L	Pack.
85620 00 002	5/32	10	18	10
85620 00 004	1/4	12.5	20	10
85620 00 005	5/16	14	21.5	10
85620 00 006	3/8	17	25	10
85620 00 007	1/2	20	27.5	10

55625

GIUNZIONE DOPPIA

DOUBLE JOINT
DOPPELSTECKER
JONCTION DOUBLE (TECHNOPOLYMÈRE)
UNIÓN DOBLE
JUNÇÃO DUPLA

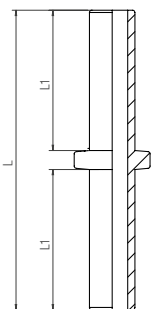

Code	Tube	L	L1	Pack.
55625 00 31 X1 NE	5/32	34.5	16	10
55625 00 31 03 NE	1/4	39.5	18.5	10
55625 00 31 X7 NE	5/16	42	19.5	10
55625 00 31 04 NE	3/8	51.5	24	10
55625 00 31 05 NE	1/2	60	28	10

85700

RIDUZIONE

REDUCER
REDUZIERUNG
RÉDUCTION ENCLIQUETABLE (TECHNOPOLYMÈRE)
REDUCCION
REDUÇÃO

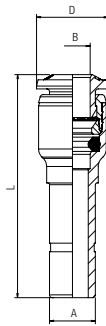

Code	A	B	L	D	Pack.
85700 00 001	1/4	5/32	34	10	10
85700 00 008	5/16	5/32	38	12	10
85700 00 002	5/16	1/4	39	12.5	10
85700 00 003	3/8	1/4	42.5	12.5	10
85700 00 004	3/8	5/16	42	14	10
85700 00 005	1/2	1/4	38.5	12.5	10
85700 00 006	1/2	5/16	41.5	14	10
85700 00 007	1/2	3/8	48.5	17	10

85705

RIDUZIONE

REDUCER
REDUZIERUNG
RÉDUCTION ENCLIQUETABLE (TECHNOPOLYMÈRE)
REDUCCION
REDUÇÃO

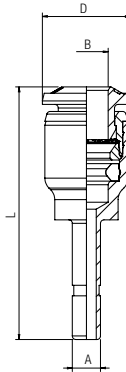

Code	A	B	L	D	Pack.
85705 00 001	5/32	1/4	36	12	10
85705 00 002	1/4	5/16	38.5	14	10
85705 00 003	1/4	3/8	42	17	10
85705 00 004	5/16	3/8	43	17	10
85705 00 005	3/8	1/2	48	20	10

87800

CARTUCCE A COMPRESIONE

PUSH-FIT CARTRIDGES
EINPRESSPATRONEN
CARTOUCHE
CARTUCHO A COMPRESIÓN
CARTUCHO DE COMPRESSÃO

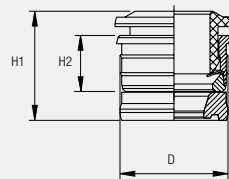

Code	Tube	D	H1	H2	Pack.
87800 00 001	1/8	6.7	9.7	5	100
87800 00 002	5/32	8.7	11	5.6	100
87800 00 003	1/4	10.75	13.4	6.9	100
87800 00 004	5/16	12.7	13.4	6.9	100
87800 00 005	3/8	15.7	16	8.5	100
87800 00 006	1/2	18.3	18.3	9.5	100

SEDE

SEAT
BOHRUNGEN
IMPLANTATION
SEDE
SEDE

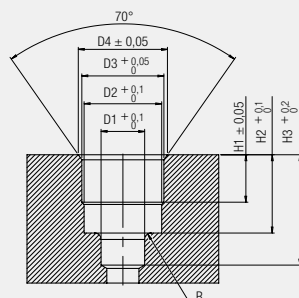

Dimensioni sedi cartucce a compressione.

Seats dimensions push-fit cartridges.
Bohrungsangaben für die einpresspatronen.
Dimensions des logements des cartouches.
Dimensiones sede cartucho a compresión.
Dimensão da sede do cartucho de compressão.

Tube	D1	D2	D3	D4	H1	H2	H3	R
1/8	3.4	6.05	6.4	6.95	3.7	6.1	8.6	0.5
5/32	4.2	7.45	8.4	9	3.75	6.5	9.5	0.5
1/4	6.6	9.35	10.45	11.35	5	8.5	11.5	0.5
5/16	8.2	11.4	12.4	12.9	5.2	8.5	12.5	0.75
3/8	9.7	14.5	15.4	16	6.7	10.5	15	0.75
1/2	13	17	18	19	7.5	12.1	17	1

ISTRUZIONI DI MONTAGGIO CARTUCCE A COMPRESSIONE ART. 87800

PUSH-FIT CARTRIDGES ASSEMBLING INSTRUCTIONS ART. 87800

ANLEITUNG FÜR DIE MONTAGE DER EINPRESSPATRONEN ART. 87800

INSTRUCTION DE MONTAGE POUR CARTOUCHE RÉF. 87800

INSTRUCCIONES DE MONTAJE CARTUCHO A COMPRESIÓN ART. 87800

INSTRUÇÕES DE MONTAGEM DO CARTUCHO DE COMPRESSÃO CÓD. 87800

1

Realizzare la sede per la cartuccia utilizzando l'apposita fresa Art. 55801.

Make the seat for the cartridge utilizing the suitable tool Art. 55801.

Machen sie die Sitze für die Einpresspatronen mit dem entsprechenden Stufenbohrer Art. 55801.

Usiner le logement de la cartouche à l'aide de l'outil de perçage réf. 55801.

Realizar la sede para el cartucho utilizando la correspondiente fresa Art. 55801.

Realize a furação da sede para o cartucho utilizando a fresa de cód. 55801.



2

Inserire la guarnizione sagomata nell'apposita sede.

Insert the seal inside of the seat.

Legen sie die dichtung in die Bohrung ein.

Insérer le joint dans le logement.

Insertar la junta en la correspondiente sede.

Insira vedação no fundo da sede.



3

Inserire la cartuccia nel canotto di montaggio Art. 55802.

Insert the cartridge into the assembling tool Art. 55802.

Legen sie die Einpresspatrone in das Montage-werkzeug Art. 55802.

Insérer la cartouche dans l'outil de montage réf. 55802.

Insertar el cartucho en el útil de montaje Art. 55802.

Insira o cartucho no tubete de montagem Cód. 55802.



4

Premere la cartuccia all'interno della sede fino ad arrivare in battuta sul piano con il canotto.

Press the cartridge inside of the seat until it will be reached the abutment surface with the assembling tool.

Drücken sie die Einpresspatrone in die Bohrung, bis das Montagewerkzeug am Werkstück ansteht.

Presser la cartouche dans le logement jusqu'à ce que l'outil de montage soit en contact avec la surface.

Empujar el cartucho al interior de la sede hasta llegar al plano con el útil de montaje.

Pressione o cartucho no interior da sede até tocar a superfície de montagem com o tubete.



55801

FRESA SEDE CARTUCCE A COMPRESSIONE

TOOL FOR PUSH-FIT CARTRIDGES SEAT

STUFENBOHRER FÜR EINPRESSPATRONEN

OUTIL DE PERÇAGE POUR CARTOUCHE

FRESA SEDE CARTUCHO A COMPRESIÓN

FRESA PARA FURAÇÃO DA SEDE DO CARTUCHO DE COMPRESSÃO



Code	Tube	ø Body	Pack.
55801 00 007	1/8	10	1
55801 00 001	5/32	10	1
87801 10 002	1/4	12	1
55801 00 003	5/16	12	1
87801 10 003	3/8	16	1
87801 10 004	1/2	16	1

55802

CANOTTO MONTAGGIO CARTUCCE A COMPRESSIONE

ASSEMBLING TOOL FOR PUSH-FIT CARTRIDGES

MONTAGWERKZEUG FÜR EINPRESSPATRONEN

OUTIL DE MONTAGE POUR CARTOUCHE

ÚTIL DE MONTAJE CARTUCHO A COMPRESIÓN

TUBETE PARA MONTAGEM DO CARTUCHO DE COMPRESSÃO



Code	Tube	Pack.
55802 00 001	1/8	1
55802 00 002	5/32	1
55802 00 004	1/4	1
55802 00 005	5/16	1
55802 00 006	3/8	1
55802 00 007	1/2	1

50980

CLIP DI SICUREZZA

SECURITY CLIPS
SICHERHEITSClip
CLIP DE SECURITÉ
CLIP DE SEGURIDAD ROJO
CLIP DE SEGURANÇA

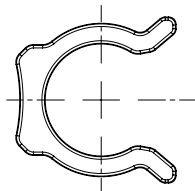

Code	Tube	Pack.
50980 00 32 X1 RO	5/32	50
50980 00 32 X4 RO	1/4	50
50980 00 32 X7 RO	5/16	50
50980 00 32 X9 RO	3/8	50
50980 00 32 Y1 RO	1/2	50

50990

LEVA SGANCIO ADATTATORI

TOOL FOR DISASSEMBLING
LÖSEWERKZEUG
OUTIL DE DÉMONTAGE
LLAVE DE DESMONTAJE
FERRAMENTA PARA DESMONTAGEM

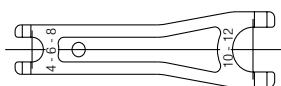

Code	Pack.
50990 00 001	10

50006

ANELLO DI TENUTA PER FILETTI CONICI "UNIVERSAL SHORT"

THREAD PACKING FOR THE "UNIVERSAL SHORT" TAPER THREADS
DICHTRINGE FÜR KONISCHE GEWINDE "UNIVERSAL SHORT"
BAGUE D'ÉTANCHÉITÉ POUR FILETAGES CONIQUES "UNIVERSAL SHORT"
JUNTA DE CIERRE PARA ROSCAS CÓNICAS "UNIVERSAL SHORT"
ANEL DE VEDAÇÃO PARA ROSCAS CÔNICA "UNIVERSAL SHORT"

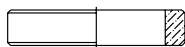

Code	Thread	Pack.
50006 00 24 02 00	1/8	10
50006 00 24 03 00	1/4	10
50006 00 24 04 00	3/8	10
50006 00 24 05 00	1/2	10