

Serie Adapters

 2000 Pag. 14.6	New  2010 Pag. 14.6	 2020 Pag. 14.6	 2030 Pag. 14.6	New  2040 Pag. 14.7	New  2050 Pag. 14.7	 2060 Pag. 14.7	New  2070 Pag. 14.8	 2080 Pag. 14.8
New  2090 Pag. 14.8	New  2092 Pag. 14.9	 2095 Pag. 14.9	 2096 Pag. 14.9	 2110 Pag. 14.9	 2115 Pag. 14.10	 2116 Pag. 14.10	 3000 Pag. 14.10	 3010 Pag. 14.10
New  3015 Pag. 14.11	 3015V Pag. 14.11	New  3020 Pag. 14.11	 3021 Pag. 14.11	 3025 Pag. 14.12	 3026 Pag. 14.12	 3030 Pag. 14.12	New  3040 Pag. 14.13	 3044 Pag. 14.14
New  3045 Pag. 14.14	New  3047 Pag. 14.15	 3050 Pag. 14.15	 3055 Pag. 14.15	 3060 Pag. 14.15	 1704 Pag. 14.16	 4000 Pag. 14.16	 4010 Pag. 14.16	 4020 Pag. 14.16
 4030 Pag. 14.17	New  4040 Pag. 14.17	 4050 Pag. 14.17	 5000 Pag. 14.17	 5010 Pag. 14.18	 5020 Pag. 14.18	 5050 Pag. 14.18	 6000 Pag. 14.18	 6010 Pag. 14.19
 6020 Pag. 14.19	 6025 Pag. 14.19	 6030 Pag. 14.19	 6040 Pag. 14.20	 6047 Pag. 14.20	 6048 Pag. 14.20	 6070 Pag. 14.20	 6080 Pag. 14.21	 6090 Pag. 14.21
New  82205 Pag. 14.21	New  82241 Pag. 14.22	 82242 Pag. 14.22	 7000 Pag. 14.23	New  7005 Pag. 14.23	New  7010 Pag. 14.23	 7020 Pag. 14.23	 7030 Pag. 14.24	 7040 Pag. 14.24
 7050 Pag. 14.24	 7060 Pag. 14.24	 7070 Pag. 14.25	 7080 Pag. 14.25	 AS7100 Pag. 14.26	 7100 Pag. 14.26	 7110 Pag. 14.27	 7120 Pag. 14.27	 7130 Pag. 14.27
 7140 Pag. 14.28	 7150 Pag. 14.28							

Serie Food&Drinks - Fittings CW510L

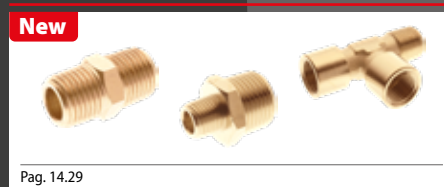

Serie 1800 - Fittings with bayonet connection



Serie 15000 - Hose adapters for plastic tubes

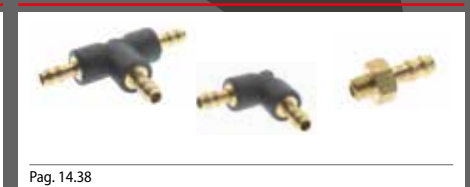

RACCORDI FILETTATI

NICKEL-PLATED BRASS ADAPTORS

GEWINDEVERSCHRAUBUNGEN

ACCESSOIRES DE RACCORDEMENT- ADAPTATEURS LAITON

RACORDAJE ROSCADO

ACESSÓRIOS ROSCADOS EM LATÃO NIQUELADO



Serie Adapters

La serie di Aignep, completamente realizzati in ottone nichelato, costituiscono il completamento dell'offerta in termini di adattatori, riduzioni, tappi e componenti per realizzare al meglio le vostre applicazioni e circuiterie. Con prestazioni importanti in termini di pressioni e temperature (+300°C), sono realizzati in una ampia gamma base. Filettature BSPT, BSPP e Metriche.

Completano la gamma un'importante serie di manifold di distribuzione in alluminio e di silenziatori in bronzo sinterizzato e materiali plastici.

Principali vantaggi

- Gamma completa M5 - 1"
- Filettati e portagomma
- Compatibilità numerosi fluidi industriali
- Robustezza meccanica
- Versione attacchi a baionetta standard
- Silicon Free

Applicazioni

- Aria Compressa
- Automazione Pneumatica
- Circuiti acqua industriale
- Gas inerti, vapore, fluidi
- Vuoto

Les adaptateurs en laiton nickelé offre un grand choix de configurations possibles. Aignep propose une large gamme de mamelons, réductions, bouchons, T, L, adaptateurs pour tuyaux.

Performances élevées en terme de pression et de température (+ 300 °C).
Filetages BSPT, BSPP et métrique.

Les nourrices de distribution en aluminium et les silencieux complètent la gamme.

Principaux avantages

- Gamme complète M5 - 1"
- Tous fluides compatibles
- Résistance mécanique
- Standard et raccords Baïonnettes
- Sans silicone

Applications

- Air comprimé
- Automatismes pneumatiques
- Circuits d'eau industrielle
- Gaz neutres, vapeur
- Vide

Nickel-plated brass threaded adaptors is the argest range of Aignep.

Countless configurations in multiple sizes: nipples, reductions, plugs, T, L, hose adaptors.

High performances in pressure and temperatures (+300°C).

Sharp threads BSPT, BSPP & Metric.

Aluminium manifolds and silencers complete the range.

Main advantages

- Complete Range M5 - 1"
- All Fluids compatible
- Mechanical Resistance
- Standard and Bayonet connection
- Silicon Free

Applications

- Compressed Air
- Pneumatic Automation
- Industrial water circuits
- Inert Gases, Fluids, Steam
- Vacuum

Die Messing vernickelten Gewindeadapter von Aignep, komplettieren das umfangreiche Sortiment.

Unzählige Konfigurationen in verschiedenen Größen: Nippel, Reduzierungen, Stopfen, T- und L-Verschraubungen, Schlauchtüllen, etc. Hohe Leistungen im Druck- und Temperaturbereich (+ 300 °C).

Präzise Gewinde: BSPT, BSPP und metrisch. Verteilerblöcke aus Aluminium und Schalldämpfer runden das Angebot ab

Hauptvorteile

- Vollständiges Sortiment M5 - 1"
- Kompatibel mit allen Medien
- Mechanische Festigkeit
- Standard and Bajonett Anschluss
- Silikonfrei

Anwendungen

- Druckluft
- Pneumatische Automation
- Industrielle Wasserkreisläufe
- Inertgase, Flüssigkeiten, Dampf
- Vakuum

La serie de accesorios Aignep, completamente realizada en Latón niquelado, completa la oferta en términos de adaptadores, reducciones, tapones, y componentes para realizar de la mejor forma vuestras aplicaciones y circuitos.

Con importantes prestaciones en términos de presión y temperatura (+300°C), son realizados en una amplia gama base. Roscas BSPT, BSPP y Métricas.

Completan la gama una importante serie de regletas de distribución en aluminio y de silenciadores en bronce sinterizado y material plástico.

Principales ventajas

- Gama completa M5-1" – roscados y espiga
- Compatibilidad con numerosos fluidos industriales
- Robustez mecánica
- Versión conexión a bayoneta standard
- Libres de silicona

Aplicaciones

- Aire comprimido
- Automatización neumática
- Circuitos de agua industrial
- Gases inertes, vapor, fluidos
- Vacío

Accessórios roscados em latão niquelado é o maior range de itens da linha da Aignep.

Incontáveis configurações em diversos tamanhos: niples, reduções, plugs, T, L, Espiões para mangueiras.

Itens para alta pressão e alta temperatura (+300°C).

Roscas precisas: BSPT, BSPP & Métrica, manifolds em alumínio e silenciadores completas o range de produtos.

Principais vantagens

- Completo Range de tamanhos : de M5 a 1"
- Compatível com todos os fluidos
- Resistência Mecânica
- Conexões do tipo standard e baioneta
- Livre de Silicone

Aplicações

- Ar Comprimido
- Automação Pneumática
- Circuitos de Água Industrial
- Gases Inertes, Fluidos, Vapor
- Vácuo

CARATTERISTICHE TECNICHE

TECHNICAL CHARACTERISTICS
 TECHNISCHE ANGABEN
 CARACTÉRISTIQUES TECHNIQUES
 CARACTERÍSTICAS TÉCNICAS
 CARACTERÍSTICAS TÉCNICAS

Norma di Riferimento

Reference standard

Entspricht der Norm

Norme de référence

Normativa de referencia

Norma de referência

1907/2006

REACH ✓

2011/65/CE

ROHS ✓

PED
2014/68/UE

SILICON
FREE

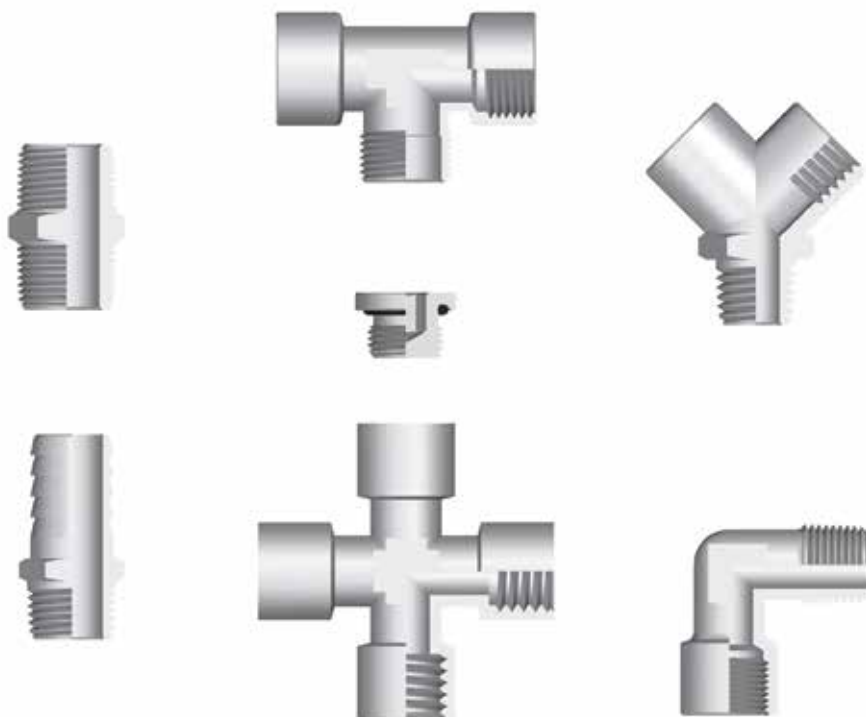
Materiali e Componenti
IT

La maggior parte degli articoli di questa serie è composta da un unico particolare in OT UNI EN 12164/5 CW 614/7N e subisce un trattamento galvanico di nichelatura.

Articoli prodotti in materiali diversi, verranno specificati all'interno del catalogo.

Component Parts and Materials
GB

The main part of these fittings is made in OT UNI EN 12164/5 CW 614/7N and undergo to a nickel-plating process.

Different materials will be specified in the catalogue.

Komponenten und Materialien
DE

Die meisten Artikel in dieser Serie werden aus OT UNI EN 12164/5 CW 614/7N hergestellt und werden einer Nickel Oberflächenbehandlung unterzogen.

Wenn Artikel mit anderen Materialien hergestellt sind, so wird das im Katalog direkt beim Produkt angegeben.

Matériaux et Composants
FR

La majeure partie des raccords de ce chapitre est fabriquée en laiton OT UNI EN 12164/5 CW 614/7N et traités par nickelage.

Les autres matériaux sont précisés dans le catalogue sous l'article concerné.

Materiales y Componentes
ES

La mayor parte de los artículos de esta serie está compuesta de un solo material latón (OT UNI EN 12164/5 CW 614/7N) sometido a un tratamiento galvanico de niquelatura.

Artículos producidos en materiales diversos, vendrán especificados al interior del catálogo.

Materiais e Componentes
PT

A maior parte dos itens desta série é fabricada em OT UNI EN 12164/5 CW 614/7N e passa por um tratamento galvânico de niquelamento.

Itens produzidos com materiais diferentes, estarão especificados no catálogo.



Misura
Size
Größe
Dimensions
Medida
Tamanho

Pressione consigliata
Pressure advised
Empfohlener druck
Pression conseillée
Presión recomendada
Pressão aconselhada

1/8	-0.99 bar ~ 150 bar
1/4	-0.99 bar ~ 100 bar
3/8	-0.99 bar ~ 75 bar
1/2	-0.99 bar ~ 50 bar
3/4	-0.99 bar ~ 85 bar
1"	-0.99 bar ~ 80 bar

Temperature massima

Maximum temperature

Maximum temperatur

Température maximale

Temperatura máxima

Temperatura máxima

+ 300 °C

Fluidi compatibili

Acqua / Olio / Aria compressa

Fluidi in genere per l'impiantistica idraulica, oleodinamica, idropneumatica, ecc.

Fluids

Water / Oils / Compressed air

Fluids in general for the hydraulic, pneumatic and oildynamic plants etc.

Geeignete Medien

Wasser / Oel / Druckluft

Medien im Allgemeinen für hydraulische-, hydropneumatische- und pneumatische Anlagen, usw.

Fluides compatibles

Eau / Huile / Air comprimé

Fluides courants utilisés en hydraulique et pneumatique, etc.

Fluidos compatibles

Agua / Aceite / Aire comprimido

Fluidos en general para los campos hidráulicos, neumáticos y oleodinámicos, etc.

Fluidos compatíveis

Água / Óleo / Ar comprimido

Fluidos em geral para aplicações hidráulicas, oleodinâmicas, hidropneumáticas, etc.

Tubi di Collegamento

IT

Tubi e raccordi in genere.

Connection Tubes

GB

Tubes and fittings in general.

Geeignete Rohre

DE

Rohre und Verschraubungen im Allgemeinen.

Tubes Conseillés

FR

Raccords et tubes compatibles.

Tubos de Conexión

ES

Tubo y racordaje en general.

Tubos de Conexão

PT

Tubos e conexões em geral.

Filettatura

IT

 Gas conica conforme ISO 7.1, BS 21, DIN 2999.
 Gas cilindrica conforme ISO 228 Classe A.
 Metrica conforme ISO R/262.
 NPTF conforme ANSI B1.20.5

Threads

GB

 Tapered gas in conformity with ISO 7.1, BS 21, DIN 2999.
 Parallel gas in conformity with ISO 228 Class A.
 Metric in conformity with ISO R/262.
 NPTF in conformity with ANSI B1.20.5

Gewindearten

DE

 Konisches Gewinde nach Norm ISO 7.1, BS 21, DIN 2999.
 Zylindrisches Gewinde nach Norm ISO 228 Classe A.
 Metrisches Gewinde nach Norm ISO R/262.
 NPTF nach norm ANSI B1.20.5

Filetages

FR

 Filetage conique conforme: ISO 7.1, BS 21, DIN 2999.
 Filetage cylindrique conforme: ISO 228 Class A.
 Filetage métrique conforme: ISO R/262.
 NPTF conforme: ANSI B1.20.5

Roscas

ES

 Gas cónica conforme ISO 7.1, BS 21, DIN 2999.
 Gas cilíndrica conforme ISO 228 Clase A.
 Métrica conforme ISO R/262.
 NPTF conforme ANSI B1.20.5

Roscas

PT

 Gas cônica conforme ISO 7.1, BS 21, DIN 2999.
 Gas paralela conforme ISO 228 Classe A.
 Métrica conforme ISO R/262.
 NPTF conforme ANSI B1.20.5

2000

NIPPLO CONICO

NIPPLE (TAPER)
 DOPPELNIPPEL KONISCH
 MAMELON DOUBLE CONIQUE
 MACHÓN CÓNICO
 NIPLE COM ROSCA CÔNICA

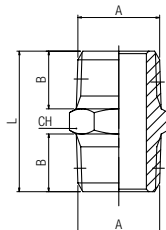

Code	A	B	L	CH	Pack.
02000 00 01 02 NB	1/8	7.5	19.5	12	10
02000 00 01 03 NB	1/4	11	27	14	10
02000 00 01 04 NB	3/8	11.5	28	17	10
02000 00 01 05 NB	1/2	14	33.5	22	10
02000 00 01 07 NB	3/4	16.5	40	27	10
02000 00 01 09 NT	1"	19	46.5	34	10

2010

NIPPLO CILINDRICO

NIPPLE (PARALLEL)
 DOPPELNIPPEL ZYLINDRISCH
 MAMELON DOUBLE, CYLINDRIQUE
 MACHÓN CILÍNDRICO
 NIPLE COM ROSCA PARALELA

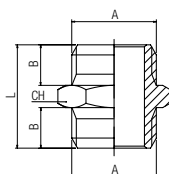

New

Code	A	B	L	CH	Pack.
02010 00 01 PG NB	M3	2.8	10	5	10
02010 00 01 B5 NB	M5	4	11.5	8	10
02010 00 01 02 NB	1/8	6	16.5	14	10
02010 00 01 03 NB	1/4	8	21	17	10
02010 00 01 04 NB	3/8	9	23	19	10
02010 00 01 05 NB	1/2	10	25.5	24	10
02010 00 01 07 NB	3/4	12	29.5	30	10
02010 00 01 09 NB	1"	12	32	40	10

2020

NIPPLO DI RIDUZIONE CONICO

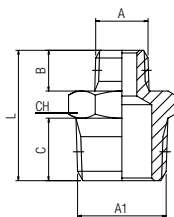
REDUCING NIPPLE (TAPER)
 DOPPELNIPPEL REDUZIERT KONISCH
 MAMELON DOUBLE INÉGAL, CONIQUE
 MACHÓN CÓNICO DE REDUCCIÓN
 NIPLE DE REDUÇÃO COM ROSCA CÔNICA



New

Code	A	A1	B	C	L	CH	Pack.
02020 00 01 AT NB	1/8	1/4	7.5	11	23.5	14	10
02020 00 01 3W NB	1/8	3/8	7.5	11.5	24	17	10
02020 00 01 4W NB	1/8	1/2	7.5	14	27	22	10
02020 00 01 7W NB	1/4	3/8	11	11.5	27.5	17	10
02020 00 01 8W NB	1/4	1/2	11	14	30.5	22	10
02020 00 01 ED NB	1/4	3/4	11	16.5	34.5	27	10
02020 00 01 AC NB	3/8	1/2	11.5	14	31	22	10
02020 00 01 AL NB	3/8	3/4	11.5	16.5	35	27	10
02020 00 01 AH NB	1/2	3/4	14	16.5	37.5	27	10
02020 00 01 AP NT	1/2	1"	14	19	41.5	34	10
02020 00 01 AS NT	3/4	1"	16.5	19	44	34	10

2030

NIPPLO DI RIDUZIONE CILINDRICO

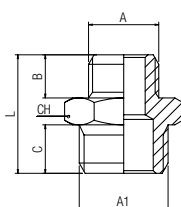
REDUCING NIPPLE (PARALLEL)
 DOPPELNIPPEL REDUZIERT ZYLINDRISCH
 MAMELON DOUBLE INÉGAL, CYLINDRIQUE
 MACHÓN CILÍNDRICO DE REDUCCIÓN
 NIPLE DE REDUÇÃO COM ROSCAPARALELA



Code	A	A1	B	C	L	CH	Pack.
02030 00 01 0W NB	M5	1/8	4	6	14.5	14	10
02030 00 01 AT NB	1/8	1/4	6	8	19	17	10
02030 00 01 3W NB	1/8	3/8	6	9	20	19	10
02030 00 01 7W NB	1/4	3/8	8	9	22	19	10
02030 00 01 8W NB	1/4	1/2	8	10	23.5	24	10
02030 00 01 AC NB	3/8	1/2	9	10	24.5	24	10
02030 00 01 AH NT	1/2	3/4	10	12	27.5	30	10

2040

RIDUZIONE CONICA

REDUCER (TAPER)
 VERGRÖßERUNG KONISCH
 GROSSISSEUR, CONIQUE
 UNIÓN CÓNICA MACHO - HEMBRA
 REDUÇÃO COM ROSCA CÔNICA

New

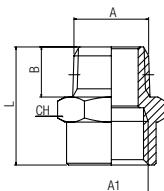

Code	A	A1	B	L	CH	Pack.
02040 00 01 2W NB	1/8	1/8	7.5	20	14	10
02040 00 01 AT NB	1/8	1/4	7.5	22	17	10
02040 00 01 3W NB	1/8	3/8	7.5	23	22	10
02040 00 01 6W NB	1/4	1/4	11	26	17	10
02040 00 01 7W NB	1/4	3/8	11	27	22	10
02040 00 01 8W NB	1/4	1/2	11	30	26	10
02040 00 01 AB NB	3/8	3/8	11.5	27.5	22	10
02040 00 01 AC NB	3/8	1/2	11.5	30.5	26	10
02040 00 01 AL NB	3/8	3/4	11.5	32.5	32	10
02040 00 01 AG NB	1/2	1/2	14	33	26	10
02040 00 01 AH NB	1/2	3/4	14	35	32	10
02040 00 01 AS NB	3/4	1"	16.5	41	41	10

2050

RIDUZIONE CILINDRICA

REDUCER (PARALLEL)
 VERGRÖßERUNG ZYLINDRISCH
 GROSSISSEUR, CYLINDRIQUE
 UNIÓN CILÍNDRICA MACHO - HEMBRA
 REDUÇÃO COM ROSCA PARALELA

New

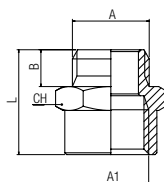

Code	A	A1	B	L	CH	Pack.
02050 00 01 0W NB	M5	1/8	4	14.5	14	10
02050 00 01 2W NB	1/8	1/8	6	17	14	10
02050 00 01 AT NB	1/8	1/4	6	20.5	17	10
02050 00 01 3W NB	1/8	3/8	6	21.5	22	10
02050 00 01 6W NB	1/4	1/4	8	22.5	17	10
02050 00 01 7W NB	1/4	3/8	8	23.5	22	10
02050 00 01 8W NB	1/4	1/2	8	26.5	26	10
02050 00 01 AB NB	3/8	3/8	9	24.5	22	10
02050 00 01 AC NB	3/8	1/2	9	27.5	26	10
02050 00 01 AL NB	3/8	3/4	9	30	32	10
02050 00 01 AG NB	1/2	1/2	10	28.5	26	10
02050 00 01 AH NB	1/2	3/4	10	31	32	10

2060

NIPPLE CONICO ORIENTABILE (3 PEZZI)

TAPER NIPPLE (3 PIECES)
 DOPPELNIPPEL KONISCH EINSTELLBAR (3 STÜCK)
 MAMELON DOUBLE 3 PIÈCES
 MACHÓN CÓNICO ORIENTABLE (3 PIEZAS)
 NIPLÉ ORIENTÁVEL COM ROSCA CÔNICA (3 PARTES)

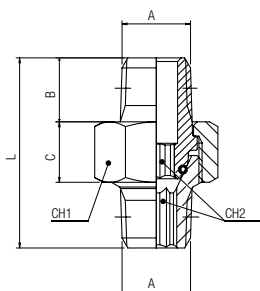
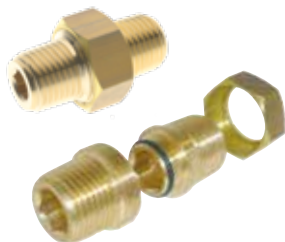

Code	A	B	C	D	L	CH1	CH2	*	Pack.
02060 00 001	1/8	9	8.5	7.5	27	15	5	15	10
02060 00 002	1/4	11.5	9.5	11	33.5	19	6	15	10
02060 00 003	3/8	13	10	11.5	36.5	22	8	20	10
02060 00 004	1/2	16	12	14	45	27	12	20	10
02060 00 005	3/4	18	17	16.5	54	36	14	40	5
02060 00 006	1"	21.5	20	19	65	46	19	40	1

Articolo non nichelato.
 Article not nichel-plated.
 Artikel nicht vernickelt.
 Article non nickelé.
 Artículo no niquelado.
 Item não niquelado.

* Coppia di serraggio (Nm).
 Torque specifications (Nm).
 Angaben Drehmoment (Nm).
 Couple de serrage (Nm).
 Par de apriete (Nm).
 Torque de aperto (Nm).

	min	max
Temperature	- 20 °C	+ 80 °C
Pressure	- 0.99 bar (-0.099 MPa)	+ 50 bar (5 MPa)

2070

PROLUNGA CILINDRICA

EXTENSION (PARALLEL)
 VERLÄNGERUNG ZYLINDRISCH
 RALLONGE ÉGALE, CYLINDRIQUE
 PROLONGACIÓN CILÍNDRICA
 PROLONGAMENTO COM ROSCA PARALELA

New

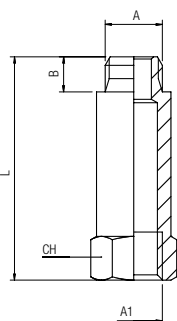

Code	A	A1	L	B	CH	Pack.
02070 00 01 YN NB	M5	M5	18.5	4	7	10
02070 00 01 BH NB	1/8	1/8	22	6	14	10
02070 00 01 UP NB	1/8	1/8	32	6	14	10
02070 00 01 BI NB	1/8	1/8	42	6	14	10
02070 00 01 UQ NB	1/8	1/8	51	6	14	10
02070 00 01 UR NB	1/4	1/4	28	8	17	10
02070 00 01 BL NB	1/4	1/4	35	8	17	10
02070 00 01 BM NB	1/4	1/4	51	8	17	10
02070 00 01 UT NB	3/8	3/8	32	9	22	10
02070 00 01 US NB	1/2	1/2	35	10	26	10

2080

RIDUZIONE CONICA

REDUCER (TAPER)
 REDUZIERUNG KONISCH
 RÉDUCTION, CONIQUE
 REDUCCIÓN CÓNICA
 REDUÇÃO COM ROSCA CÔNICA

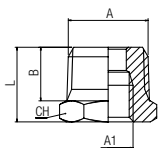

Code	A	A1	B	L	CH	Pack.
02080 00 01 5W NB	1/4	1/8	11	16	14	10
02080 00 01 9W NB	3/8	1/8	11.5	16.5	17	10
02080 00 01 AD NB	1/2	1/8	14	19.5	22	10
02080 00 01 AA NB	3/8	1/4	11.5	16.5	17	10
02080 00 01 AE NB	1/2	1/4	14	19.5	22	10
02080 00 01 AF NB	1/2	3/8	14	19.5	22	10
02080 00 01 AL NB	3/4	3/8	16.5	23.5	27	10
02080 00 01 AM NB	3/4	1/2	16.5	23.5	27	10
02080 00 01 AP NT	1"	1/2	19	27.5	34	10
02080 00 01 AQ NT	1"	3/4	19	27.5	34	10
02080 00 01 AR NT	1"1/4	1/2	22	31	45	10
02080 00 01 AU NT	1"1/4	3/4	22	31	45	10
02080 00 01 AV NT	1"1/4	1"	22	31	45	10
02080 00 01 82 NT	1"1/2	1"	22	32	50	5
02080 00 01 83 NT	2"	1"	24	36	60	5

2090

RIDUZIONE CILINDRICA

REDUCER (PARALLEL)
 REDUZIERUNG ZYLINDRISCH
 RÉDUCTION, CYLINDRIQUE
 REDUCCIÓN CILÍNDRICA
 REDUÇÃO COM ROSCA PARALELA

New

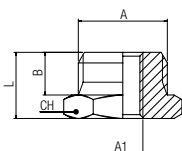

Code	A	A1	B	L	CH	Pack.
02090 00 01 YP NB	M5	M3	4	6.5	7	10
02090 00 01 OW NT	1/8	M5	6	10.5	14	10
02090 00 01 4W NB	1/4	M5	8	13	17	10
02090 00 01 5W NT	1/4	1/8	8	13	17	10
02090 00 01 9W NT	3/8	1/8	9	14	19	10
02090 00 01 AD NT	1/2	1/8	10	15.5	24	10
02090 00 01 AA NT	3/8	1/4	9	14	19	10
02090 00 01 AE NT	1/2	1/4	10	15.5	24	10
02090 00 01 AF NT	1/2	3/8	10	15.5	24	10
02090 00 01 ED NB	3/4	1/4	12	17.5	30	10
02090 00 01 AL NT	3/4	3/8	12	17.5	30	10
02090 00 01 AM NT	3/4	1/2	12	17.5	30	10
02090 00 01 AP NB	1"	1/2	12	20	40	10
02090 00 01 AQ NB	1"	3/4	12	20	40	10

2092

New

RIDUZIONE CILINDRICA CON O-RING NBR

REDUCER (PARALLEL) WITH NBR O-RING
 REDUZIERUNG ZYLINDRISCH MIT NBR O-RING
 RÉDUCTION CYLINDRIQUE AVEC JOINT TORIQUE NBR
 REDUCCIÓN CILÍNDRICA CON TORICA NBR
 REDUÇÃO COM ROSCA PARALELA COM ROSCA PARALELA E O-RING NBR

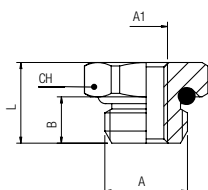

Code	A	A1	B	L	CH	R	C	Pack.
02092 00 012	M7	M5	5	12	10	4	0,8	10
02092 00 001	1/8	M5	5,4	9,4	13	8	3	10
02092 00 008	1/4	M5	7	11	16	20	6	10
02092 00 002	1/4	1/8	5,5	11,1	16	20	6	10
02092 00 003	3/8	1/8	6,5	12,6	20	70	10	10
02092 00 004	3/8	1/4	6,5	12,6	20	40	9	10
02092 00 009	1/2	1/8	9,5	14,5	25	130	12	10
02092 00 005	1/2	1/4	9,6	14,6	25	130	12	10
02092 00 006	1/2	3/8	9,6	14,6	25	110	12	10
02092 00 010	3/4	1/4	11	16	34	130	12	10
02092 00 011	3/4	3/8	11	16	34	130	12	10
02092 00 007	3/4	1/2	11,1	16	34	110	12	10

R = Coppia di rottura (Nm) C = Coppia consigliata
 Breaking Torque (Nm) Recommended Torque (Nm)
 Abscherdrehmoment (Nm) Empfohlenes Drehmoment (Nm)
 Couple de Rupture (Nm) Couple de Serrage (Nm)
 Par de Rotura (Nm) Par Aconsejado (Nm)
 Torque de Ruptura (Nm) Torque Recomendado (Nm)



Temperature

min max
 - 20 °C + 80 °C

2095

RIDUZIONE CILINDRICA

REDUCER (PARALLEL)
 REDUZIERUNG ZYLINDRISCH
 RÉDUCTION, CYLINDRIQUE
 REDUCCIÓN CILÍNDRICA
 REDUÇÃO COM ROSCA PARALELA

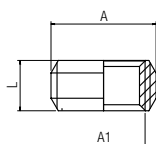

Code	A	A1	L	Pack.
02095 00 01 5W 00	1/4	1/8	8	10
02095 00 01 AA 00	3/8	1/4	9	10
02095 00 01 AF 00	1/2	3/8	10	10
02095 00 01 AM 00	3/4	1/2	14	10
02095 00 01 AQ 00	1"	3/4	20	10

Articolo non nichelato.
 Article not nichel-plated.
 Artikel nicht vernickelt.
 Article non nickelé.
 Artículo no niquelado.
 Item não niquelado.

2096

GHIERA

NUT
 MUTTER
 ÉCROU
 TUERCA
 PORCA

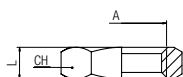

Code	A	L	CH	Pack.
02096 00 01 02 NB	1/8	4.5	14	50
02096 00 01 03 NB	1/4	5	17	50
02096 00 01 04 NB	3/8	6	20	50
02096 00 01 05 NB	1/2	6	24	50

2110

NIPPLO CONICO ORIENTABILE

ORIENTING NIPPLE (TAPER)
 SCHWENKNIPPEL KONISCH
 MAMELON ORIENTABLE, CONIQUE
 UNIÓN CÓNICA ORIENTABLE
 NIPLE ORIENTÁVEL COM ROSCA CÔNICA

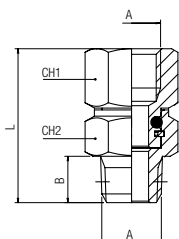

Code	A	B	CH1	CH2	L	Pack.
02110 00 001	1/8	7.5	13	13	25	10
02110 00 002	1/4	11	16	15	33	10
02110 00 003	3/8	11.5	20	17	35.5	10



Temperature

min max
 - 20 °C + 80 °C



Pressure

- 0.99 bar + 15 bar
 (-0.099 MPa) (1.5 MPa)

2115

NIPPO CILINDRICO ORIENTABILE

ORIENTING NIPPLE (PARALLEL)
 SCHWENKNIPPEL ZYLINDRISCH
 MAMELON ORIENTABLE, CYLINDRIQUE
 UNIÓN CILÍNDRICA ORIENTABLE CON TÓRICA
 NIPLE ORIENTÁVEL COM ROSCA PARALELA

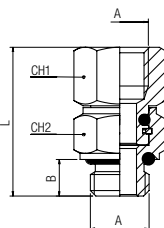

Code	A	B	CH1	CH2	L	Pack.
02115 00 001	1/8	6	13	13	24.5	10
02115 00 002	1/4	8	16	16	31	10
02115 00 003	3/8	9	20	18	34.5	10

	min	max
Temperature	- 20 °C	+ 80 °C
Pressure	- 0.99 bar (-0.099 MPa)	+ 15 bar (1.5 MPa)

2116

NIPPO MASCHIO CILINDRICO ORIENTABILE CON OR

MALE ORIENTING NIPPLE WITH OR (PARALLEL)
 DOPPELNIPPEL ZYLINDRISCH EINSTELLBAR
 MAMELON DOUBLE ORIENTABLE BSPP AVEC JOINT TORIQUE
 UNIÓN MACHO CILÍNDRICO ORIENTABLE CON OR
 NIPLE MACHO ROSCA PARALELA ORIENTÁVEL COM O-RING

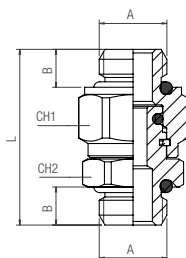

Code	A	B	L	CH1	CH2	Pack.
02116 GI 001	1/8	5,5	25	14	13	10
02116 GI 002	1/4	7	29	17	16	10
02116 GI 003	3/8	8	33	20	20	10
02116 GI 004	1/2	9,5	37	25	25	10
02116 GI 005	3/4	11	48,5	34	34	10
02116 GI 006	1"	12	52	40	40	10

Articolo non nichelato.
 Article not nichel-plated.
 Artikel nicht vernickelt.
 Article non nickelé.
 Artículo no niquelado.
 Item não niquelado.

	min	max
Temperature	- 20 °C	+ 80 °C

3000

MANICOTTO

SLEEVE
 MUFFE
 MANCHON
 MANGUITO
 LUYA

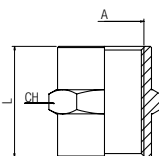

Code	A	L	CH	Pack.
03000 00 01 B5 NB	M5	11	8	10
03000 00 01 02 NB	1/8	15	14	10
03000 00 01 03 NB	1/4	22	17	10
03000 00 01 04 NB	3/8	24	22	10
03000 00 01 05 NB	1/2	30	26	10
03000 00 01 07 NB	3/4	32	32	10
03000 00 01 09 NB	1"	46	40	10

3010

MANICOTTO DI RIDUZIONE

REDUCING SLEEVE
 MUFFE REDUZIERT
 MANCHON INÉGAL
 MANGUITO DE REDUCCIÓN
 LUYA DE REDUÇÃO

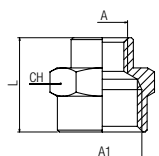

Code	A	A1	L	CH	Pack.
03010 00 01 0W NB	M5	1/8	13	14	10
03010 00 01 AT NB	1/8	1/4	19	17	10
03010 00 01 3W NB	1/8	3/8	20	22	10
03010 00 01 4W NB	1/8	1/2	24	24	10
03010 00 01 7W NB	1/4	3/8	23	22	10
03010 00 01 8W NB	1/4	1/2	25	24	10
03010 00 01 AC NB	3/8	1/2	27.5	24	10
03010 00 01 AH NB	1/2	3/4	30	30	10
03010 00 01 AI NB	1/2	1"	39	40	10
03010 00 01 AS NB	3/4	1"	41	40	10

3015

New

TAPPO MASCHIO CILINDRICO ESAGONO INCASSATO CON O-RING NBR
 MALE PLUG (PARALLEL) WITH EXAGON EMBEDDED AND NBR O-RING
 GEWINDESTOPFEN ZYLINDRISCH INNENSECHSKANT MIT O-RING NBR
 BOUCHON À 6 PANS CREUX MÂLE, CYLINDRIQUE AVEC JOINT NBR
 TAPÓN MACHO CILÍNDRICO HEXÁGONO INTERIOR CON TÓRICA NBR
 TAMPÃO MACHO COM ROSCA PARALELA E SEXTAVADO INTERNO (O-RING EM NBR)

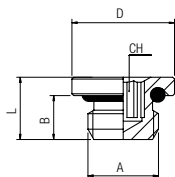

Code	A	B	L	D	CH	Pack.
03015 00 005	M5	4	6	8	2	10
03015 00 011	M7x1	5	7,5	9,5	3	10
03015 00 006	M8x1	5,4	8	12	4	10
03015 00 007	M10x1	6	8,5	14	5	10
03015 00 001	1/8	6	8,5	14	5	10
03015 00 002	1/4	8	11	17	6	10
03015 00 008	M12x1,25	8	11	15	6	10
03015 00 003	3/8	9	12,5	20	8	10
03015 00 004	1/2	10	13,5	25	10	10
03015 00 009	3/4	11,1	15,5	34	17	10
03015 00 010	1"	11,8	16	38	19	10

	min	max
Temperature	- 20 °C	+ 80 °C

3015V

TAPPO MASCHIO CILINDRICO ESAGONO INCASSATO CON O-RING FKM
 MALE PLUG (PARALLEL) WITH EXAGON EMBEDDED AND FKM O-RING
 GEWINDESTOPFEN ZYLINDRISCH INNENSECHSKANT MIT O-RING FKM
 BOUCHON À 6 PANS CREUX MÂLE, CYLINDRIQUE AVEC JOINT FKM
 TAPÓN MACHO CILÍNDRICO HEXÁGONO INTERIOR CON TÓRICA FKM
 TAMPÃO MACHO COM ROSCA PARALELA E SEXTAVADO INTERNO (O-RING EM FKM)

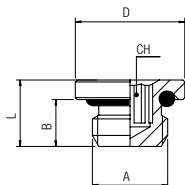

Code	A	B	L	D	CH	Pack.
03015 V0 005	M5	4	6	8	2	10
03015 V0 001	1/8	6	8,5	14	5	10
03015 V0 002	1/4	8	11	17	6	10
03015 V0 003	3/8	9	12,5	20	8	10
03015 V0 004	1/2	10	13,5	25	10	10

	min	max
Temperature	- 15 °C	+ 200 °C

EPDM Guarnizioni EPDM a richiesta - EPDM Seals are available upon request - Auf Anfrage EPDM O-Ring
 Dichtung - Joint EPDM en sur demande - Bajo EPDM demanda. Junta - Vedação EPDM de sob encomenda

3020

New

TAPPO MASCHIO CILINDRICO
 MALE PLUG (PARALLEL)
 GEWINDESTOPFEN ZYLINDRISCH
 BOUCHON À 6 PANS MÂLE, CYLINDRIQUE
 TAPÓN MACHO CILÍNDRICO
 TAMPÃO MACHO COM ROSCA PARALELA

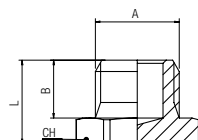

Code	A	B	L	CH	Pack.
03020 00 01 B5 NB	M5*	4,5	8	8	10
03020 00 01 B8 NB	M6x1	4,5	8	10	10
03020 00 01 NQ NB	M8x1,25	5,4	9,4	12	10
03020 00 01 JG NB	M10x1	5,4	9,4	14	10
03020 00 01 02 NB	1/8	6,5	10	14	10
03020 00 01 03 NB	1/4	9	13	17	10
03020 00 01 RL NB	M12x1	8	12	16	10
03020 00 01 D5 NB	M12x1,25	9	13	16	10
03020 00 01 04 NB	3/8	9,5	13,5	19	10
03020 00 01 05 NB	1/2	10	14,5	24	10
03020 00 01 07 NB	3/4	11	16	30	10
03020 00 01 09 NB	1"	12	17	40	10

* Installabile anche con cacciavite
 Can be also installed with a screwdriver
 Kann auch mit einem Schraubendreher angebracht werden
 Peut être installé avec un tournevis
 Se puede instalar con destornillador
 Pode ser instalado com chave de fenda

3021

TAPPO MASCHIO CONICO
 MALE PLUG (TAPER)
 GEWINDESTOPFEN KONISCH
 BOUCHON À 6 PANS MÂLE, CÓNIQUE
 TAPÓN MACHO CÓNICO
 TAMPÃO MACHO CÔNICA

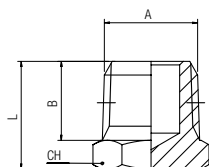

Code	A	B	L	CH	Pack.
03021 00 01 02 NB	1/8	7,5	11	10	10
03021 00 01 03 NB	1/4	11	15	14	10
03021 00 01 04 NB	3/8	11,5	15,5	17	10
03021 00 01 05 NB	1/2	14	18,5	22	10
03021 00 01 07 NB	3/4	16,5	21,5	27	10
03021 00 01 09 NB	1"	19	25	34	10

3025

TAPPO MASCHIO CONICO

MALE PLUG (TAPER)

GEWINDESTOPFEN KONISCH

BOUCHON À 6 PANS CREUX, CONIQUE

TAPÓN MACHO CÓNICO HEXÁGONO INTERIOR

TAMPÃO MACHO COM ROSCA CÔNICA

Code	A	B	H	CH	Pack.
03025 00 01 02 NB	1/8	7.5	5	5	10
03025 00 01 03 NB	1/4	10	7	6	10
03025 00 01 04 NB	3/8	11	7	8	10
03025 00 01 05 NB	1/2	13	8	10	10

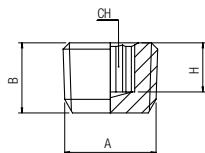

3026

TAPPO MASCHIO CILINDRICO

MALE PLUG (PARALLEL)

GEWINDESTOPFEN ZYLINDRISCH

BOUCHON À 6 PANS CREUX, CYLINDRIQUE

TAPÓN MACHO CILÍNDRICO HEXÁGONO INTERIOR

TAMPÃO MACHO COM ROSCA PARALELA

Code	A	B	D	E	H	CH	Pack.
03026 00 01 02 NB	1/8	8	8	2	5	5	10
03026 00 01 03 NB	1/4	11	11	3	7	6	10
03026 00 01 04 NB	3/8	12.5	14.5	3.5	8.5	8	10
03026 00 01 05 NB	1/2	14	18	4	10	10	10
03026 00 01 07 NB	3/4	14	21.5	3	10	12	10

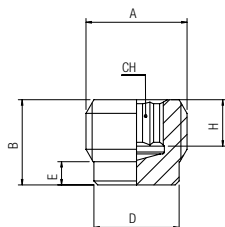

3030

TAPPO FEMMINA

FEMALE PLUG

STOPFEN INNENGEW.

BOUCHON FEMELLE

TAPÓN HEMBRA

TAMPÃO COM ROSCA FÊMEA

Code	A	B	L	CH	Pack.
03030 00 01 02 NB	1/8	7.5	11	12	10
03030 00 01 03 NB	1/4	11	19	14	10
03030 00 01 04 NB	3/8	11.5	20	17	10
03030 00 01 05 NB	1/2	14	22	19	10

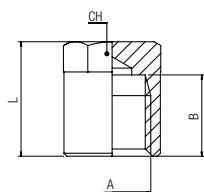

3040

PORTAGOMMA MASCHIO CONICO

MALE HOSE ADAPTER (TAPER)

SCHLAUCHTÜLLE AUSSENGEW. KONISCH

DOUILLE ANNELÉE, CONIQUE

ESPIGA MACHO CÔNICA

ESPIGÃO COM ROSCA MACHO CÔNICA

New

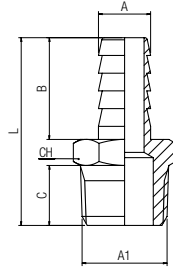

Code	A	A1	B	C	L	CH	Pack.
03040 00 01 BQ NB	4	1/8	19,5	7,5	32	12	10
03040 00 01 BS NB	6	1/8	19,5	7,5	32	12	10
03040 00 01 BT NB	6	1/4	19,5	11	35,5	14	10
03040 00 01 BZ NB	7	1/8	19,5	7,5	32	12	10
03040 00 01 BX NB	7	1/4	19,5	11	35,5	14	10
03040 00 01 BY NB	8	1/8	19,5	7,5	32	12	10
03040 00 01 BJ NB	8	1/4	19,5	11	35,5	14	10
03040 00 01 BK NB	8	3/8	19,5	11,5	36	17	10
03040 00 01 CA NB	9	1/8	19,5	7,5	32	12	10
03040 00 01 CB NB	9	1/4	19,5	11	35,5	14	10
03040 00 01 CC NB	9	3/8	19,5	11,5	36	17	10
03040 00 01 CD NB	9	1/2	19,5	14	39	22	10
03040 00 01 CE NB	10	1/8	19,5	7,5	32	12	10
03040 00 01 CF NB	10	1/4	19,5	11	35,5	14	10
03040 00 01 CG NB	10	3/8	19,5	11,5	36	17	10
03040 00 01 CH NB	10	1/2	19,5	14	39	22	10
03040 00 01 VB NB	11	1/8	19,5	7,5	32	12	10
03040 00 01 RP NB	11	1/4	19,5	11	35,5	14	10
03040 00 01 QR NB	11	3/8	19,5	11,5	36	17	10
03040 00 01 VF NB	11	1/2	19,5	14	39	17	10
03040 00 01 CI NB	12	1/4	19,5	11	35,5	14	10
03040 00 01 CL NB	12	3/8	19,5	11,5	36	17	10
03040 00 01 CM NB	12	1/2	19,5	14	39	22	10
03040 00 01 CN NB	14	3/8	19,5	11,5	36	17	10
03040 00 01 DB NB	14	1/2	19,5	14	39	22	10
03040 00 01 5P NB	15	1/4	19,5	11	35,5	22	10
03040 00 01 1G NB	15	3/8	19,5	11,5	36	17	10
03040 00 01 CP NB	15	1/2	19,5	14	39	22	10
03040 00 01 VG NB	15	3/4	19,5	14,5	43,5	27	10
03040 00 01 CQ NB	16	3/8	19,5	11,5	36	17	10
03040 00 01 CR NB	16	1/2	19,5	14	39	22	10
03040 00 01 CS NB	16	3/4	19,5	16,5	43,5	27	10
03040 00 01 CT NB	17	3/8	19,5	11,5	36	18	10
03040 00 01 CU NB	17	1/2	19,5	14	39	22	10
03040 00 01 CV NB	18	3/8	19,5	11,5	36	19	10
03040 00 01 CZ NB	18	1/2	19,5	14	39	22	10
03040 00 01 CX NB	18	3/4	19,5	16,5	43,5	27	10
03040 00 01 R7 NB	20	3/8	19,5	11,5	36	21	10
03040 00 01 C1 NB	20	1/2	30	14	49,5	22	10
03040 00 01 R8 NB	20	3/4	30	13,5	50,5	27	10
03040 00 01 VC NB	21	3/8	30	11,5	47,5	22	10
03040 00 01 VH NB	21	1/2	30	14	49,5	22	10
03040 00 01 VI NB	21	3/4	30	14,5	54	27	10
03040 00 01 C4 NB	25	3/4	30	14,5	51,5	27	10
03040 00 01 DL NB	25	1"	30	16	53,5	34	10
03040 00 01 VD NB	27	3/4	30	14,5	52,5	28	10
03040 00 01 UL NB	27	1"	30	16	53,5	34	10
03040 00 01 VE NB	34	1"	30	16	55	36	10

3044

PORTAGOMMA MASCHIO CILINDRICO CON O-RING

MALE HOSE ADAPTER (PARALLEL) WITH O-RING
 SCHLAUCHTÜLLE AUSSENGEW. ZYLINDRISCH MIT O-RING
 DOUILLE ANNELÉE, CYLINDRIQUE AVEC JOINT TORIQUE
 ESPIGA MACHO CILÍNDRICA CON TÓRICA
 ESPIGÃO COM ROSCA MACHO PARALELA E O-RING

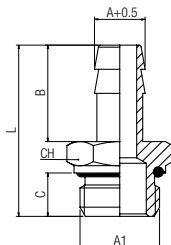

Code	A	A1	B	C	L	CH	Pack.
03044 00 001	4.5	M5	15	4	24	8	10
03044 00 023	6	1/4	20	8	34.5	16	10
03044 00 002	7	1/8	20	6	31	13	10
03044 00 003	7	1/4	20	8	34.5	16	10
03044 00 004	8	1/8	20	6	31	13	10
03044 00 005	8	1/4	20	8	34.5	16	10
03044 00 024	8	3/8	20	9	35.5	19	10
03044 00 015	8	1/2	20	10	37.5	24	10
03044 00 006	9	1/8	20	6	31	13	10
03044 00 007	9	1/4	20	8	34.5	16	10
03044 00 008	9	3/8	20	9	35.5	19	10
03044 00 025	10	1/4	20	8	34.5	16	10
03044 00 026	10	3/8	24	9	39.5	19	10
03044 00 027	10	1/2	22	10	39.5	24	10
03044 00 009	12	1/4	20	8	34.5	16	10
03044 00 010	12	3/8	20	9	35.5	19	10
03044 00 011	12	1/2	22	10	39.5	24	10
03044 00 016	13	1/2	22	10	39.5	24	10
03044 00 028	14	1/4	24	8	38.5	16	10
03044 00 020	14	3/8	24	9	39.5	19	10
03044 00 021	14	1/2	24	10	41.5	24	10
03044 00 012	17	3/8	24	9	39.5	19	10
03044 00 013	17	1/2	24	10	41.5	24	10
03044 00 017	19	3/4	30	11.1	49	33	10
03044 00 022	20	3/4	35	11	54	33	10
03044 00 018	25	1"	30	11.8	49.7	37	10
03044 00 019	27	1"	30	11.8	49.7	37	10

	min	max
Temperature	- 20 °C	+ 80 °C

3045

New

PORTAGOMMA MASCHIO CILINDRICO

MALE HOSE ADAPTER (PARALLEL)
 SCHLAUCHTÜLLE AUSSENGEW. ZYLINDRISCH
 DOUILLE ANNELÉE, CYLINDRIQUE
 ESPIGA MACHO CILÍNDRICA
 ESPIGÃO COM ROSCA MACHO PARALELA

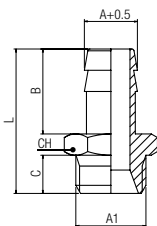

Code	A	A1	B	C	L	CH	Pack.
03045 00 01 6Q NB	3	M5	7,5	4	15,5	8	10
03045 00 01 BQ NB	4	1/8	20	6	30	14	10
03045 00 01 8S NB	4.5	M5	15	4	23	8	10
03045 00 01 BS NB	6	1/8	20	6	30	14	10
03045 00 01 BT NB	6	1/4	20	8	33	17	10
03045 00 01 BZ NB	7	1/8	20	6	30	14	10
03045 00 01 BX NB	7	1/4	20	8	33	17	10
03045 00 01 BY NB	8	1/8	20	6	30	14	10
03045 00 01 BJ NB	8	1/4	20	8	33	17	10
03045 00 01 CA NB	9	1/8	20	6	30	14	10
03045 00 01 CB NB	9	1/4	20	8	33	17	10
03045 00 01 CC NB	9	3/8	20	9	34	19	10
03045 00 01 CD NB	9	1/2	20	10	35,5	24	10
03045 00 01 VB NB	11	1/8	20	6	30	14	10
03045 00 01 RP NB	11	1/4	20	8	33	17	10
03045 00 01 QR NB	11	3/8	20	9	34	19	10
03045 00 01 VF NB	11	1/2	20	20	35,5	24	10
03045 00 01 CI NB	12	1/4	20	8	33	17	10
03045 00 01 CL NB	12	3/8	20	9	34	19	10
03045 00 01 CM NB	12	1/2	22	10	37,5	24	10
03045 00 01 5P NB	15	1/4	20	8	33	17	10
03045 00 01 1G NB	15	3/8	20	8	34	19	10
03045 00 01 CP NB	15	1/2	22	10	37,5	24	10
03045 00 01 VG NB	15	3/4	22	12	39,5	30	10
03045 00 01 CT NB	17	3/8	24	9	38	19	10
03045 00 01 CU NB	17	1/2	24	10	39,5	24	10
03045 00 01 TA NB	19	3/4	24	12	41,5	30	10
03045 00 01 VI NB	21	3/4	24	12	41,5	30	10

3047

New

PORTAGOMMA INTERMEDIO

STRAIGHT HOSE ADAPTOR
 VERBINDUNGSVERSCHRAUBUNG MIT SCHLAUCHTÜLLEN
 DOUILLE ANNELÉE DE JONCTION
 EPIGA DOBLE
 CONEXÃO ESPIGÃO RETA

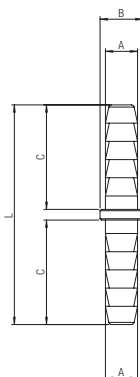

Code	A	B	C	L	Pack.
03047 00 01 X4 NB	6	8	19,5	41	10
03047 00 01 X7 NB	8	10	19,5	41	10
03047 00 01 X9 NB	10	12	19,5	42	10
03047 00 01 Y1 NB	12	14	19,5	42	10

3050

PORTAGOMMA FEMMINA

FEMALE HOSE ADAPTER
 SCHLAUCHTÜLLE INNENGEW.
 DOUILLE ANNELÉE FEMELLE
 EPIGA HEMBRA
 ESPIGÃO COM ROSCA FÊMEA

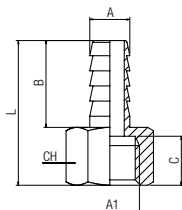

Code	A	A1	B	C	L	CH	Pack.
03050 00 01 BS NB	6	1/8	19,5	8,5	30	14	10
03050 00 01 BT NB	6	1/4	19,5	11	32,5	17	10
03050 00 01 BZ NB	7	1/8	19,5	8,5	30	14	10
03050 00 01 BX NB	7	1/4	19,5	11	32,5	17	10
03050 00 01 BJ NB	8	1/4	19,5	11	32,5	17	10
03050 00 01 CB NB	9	1/4	19,5	11	32,5	17	10
03050 00 01 CC NB	9	3/8	19,5	11,5	33,5	20	10
03050 00 01 CF NB	10	1/4	19,5	11	32,5	17	10
03050 00 01 CG NB	10	3/8	19,5	11,5	33,5	20	10
03050 00 01 CL NB	12	3/8	19,5	11,5	33,5	20	10
03050 00 01 CM NB	12	1/2	19,5	14,5	37,5	24	10

3055

RACCORDO A L PORTAGOMMA MASCHIO

MALE HOSE ADAPTER ELBOW
 WINKELSCHLAUCHTÜLLE AUSSENGEW.
 DOUILLE ANNELÉE COUDÉE
 EPIGA A L MACHO
 ESPIGÃO EM "L" COM ROSCA MACHO

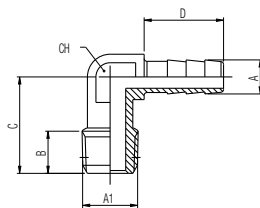

Code	A	A1	B	C	D	CH	Pack.
03055 00 01 BS NB	6	1/8	7,5	17	14	11	10
03055 00 01 BT NB	6	1/4	11	22	14	11	10
03055 00 01 BZ NB	7	1/8	7,5	17	14	11	10
03055 00 01 BX NB	7	1/4	11	22	14	11	10
03055 00 01 CB NB	9	1/4	11	22	14	11	10

3060

RACCORDO DI ATTRAVERSAMENTO

BULKHEAD CONNECTOR
 SCHOTTVERSCHRAUBUNG
 TRAVERSÉE DE CLOISON
 RACOR PASATABIQUES
 CONEXÃO PASSA-MURO

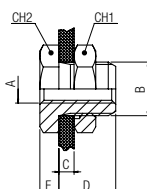

Code	A	B	C _{max}	D	E	CH1	CH2	Pack.
03060 00 001	M5	M10x1	7	10,5	3,5	14	14	10
03060 00 002	1/8	M16x1,5	10	14	4	22	19	10
03060 00 003	1/4	M20x1,5	16	21	4	27	24	10
03060 00 004	3/8	M26x1,5	15	21	5	32	30	10
03060 00 005	1/2	M28x1,5	21	27	6	36	32	10
03060 00 011	3/4	M33x1,5	22,5	30,5	6	41	41	10

1704

GHIERA

NUT
MUTTER
ECROU
TUERCA PASATABIQUES
PORCA

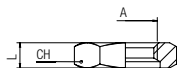

Code	A	CH	L	Pack.
01704 00 01 C8 NB	M10x1	14	4	50
01704 00 01 E3 NB	M16x1.5	22	5	50
01704 00 01 F2 NB	M20x1.5	27	6	50
01704 00 01 0V NB	M26x1.5	32	7	50
01704 00 01 H1 NB	M28x1.5	36	7	50
01704 00 01 22 NB	M33x1.5	41	8	50

4000

RACCORDO A T FEMMINA

FEMALE TEE
T-VERSCHRAUBUNG INNENGEW.
TÉ ÉGAL FEMELLE
RACOR A T HEMBRA
CONEXÃO EM "T" COM ROSCA FÊMEA

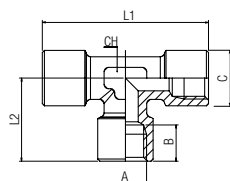

Code	A	B	L2	L1	C	CH	Pack.
04000 00 01 02 NB	1/8	8.5	19.5	39	13	12	10
04000 00 01 03 NB	1/4	11	24.5	49	16.5	13	10
04000 00 01 04 NB	3/8	12	27	54	20.5	16	10
04000 00 01 05 NB	1/2	15	32	64	25.5	20	10
04000 00 01 07 NT	3/4	16.5	36.5	73	32.5	27	10
04000 00 01 09 NT	1"	19	45	90	39.5	30	5

4010

RACCORDO A T MASCHIO

MALE TEE
T-VERSCHRAUBUNG AUSSENGEW.
TÉ ÉGAL MÂLE
RACOR A T MACHO
CONEXÃO EM "T" COM ROSCA MACHO

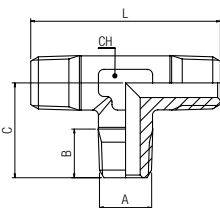

Code	A	B	C	L	CH	Pack.
04010 00 01 02 NB	1/8	8	17.5	35	12	10
04010 00 01 03 NB	1/4	11	23	46	13	10
04010 00 01 04 NB	3/8	11.5	25.5	51.5	16	10
04010 00 01 05 NB	1/2	14	29.5	59	20	10
04010 00 01 07 NT	3/4	14.5	32	64	27	10
04010 00 01 09 NT	1"	16.8	39	78	30	5

4020

RACCORDO A T FEMMINA CENTRALE

CENTRE LEG FEMALE TEE
T-VERSCHRAUBUNG INNENGEW. MITTIG
TÉ ÉGAL MÂLE, CENTRE FEMELLE
RACOR A T HEMBRA CENTRAL
CONEXÃO EM "T" COM ROSCA FÊMEA CENTRAL

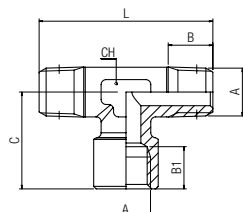

Code	A	B	B1	C	L	CH	Pack.
04020 00 01 02 NB	1/8	8	8.5	19.5	35	12	10
04020 00 01 03 NB	1/4	11	11	24.5	46	13	10
04020 00 01 04 NB	3/8	11.5	12	27	51	16	10
04020 00 01 05 NB	1/2	14	15	32	59	20	10
04020 00 01 07 NT	3/4	14.5	16.5	36.5	64	27	10
04020 00 01 09 NT	1"	16.8	19	45	78	30	5

4030

RACCORDO A T FEMMINA LATERALE

OFF SET FEMALE TEE
 T-VERSCHRAUBUNG INNENGEW. SEITLICH
 TÉ ÉGAL MÂLE, EN BOUT FEMELLE
 RACOR A T HEMBRA LATERAL
 CONEXÃO EM "T" COM ROSCA FÊMEA LATERAL

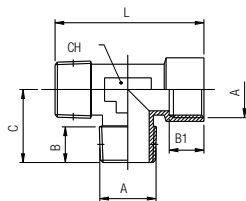

Code	A	B	B1	C	L	CH	Pack.
04030 00 01 02 NB	1/8	8	8.5	17.5	37	12	10
04030 00 01 03 NB	1/4	11	11	23	47.5	13	10
04030 00 01 04 NB	3/8	11.5	12	25.5	52.5	16	10
04030 00 01 05 NB	1/2	14	15	29.5	61.5	20	10
04030 00 01 07 NT	3/4	14.5	16.5	32	68.5	27	10
04030 00 01 09 NT	1"	16.8	19	39	84	30	5

4040

RACCORDO A T MASCHIO CENTRALE

CENTRE LEG MALE TEE
 T-VERSCHRAUBUNG AUSSENGEW. MITTIG
 TÉ ÉGAL FEMELLE, CENTRE MÂLE
 RACOR A T MACHO CENTRAL
 CONEXÃO EM "T" COM ROSCA MACHO CENTRAL

New

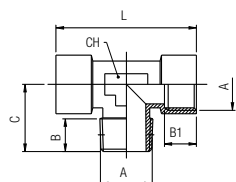

Code	A	B	B1	C	L	CH	Pack.
04040 00 01 B5 NB	M5	4	5.5	11	22	9	10
04040 00 01 02 NB	1/8	8	8.5	17.5	39	12	10
04040 00 01 03 NB	1/4	11	11	23	49	13	10
04040 00 01 04 NB	3/8	11.5	12	25.5	54	16	10
04040 00 01 05 NB	1/2	14	15	29.5	64	20	10
04040 00 01 07 NT	3/4	14.5	16.5	32	73	27	10
04040 00 01 09 NT	1"	16.8	19	39	90	30	5

4050

RACCORDO A T MASCHIO LATERALE

OFF SET MALE TEE
 T-VERSCHRAUBUNG AUSSENGEW. SEITLICH
 TÉ ÉGAL FEMELLE, EN BOUT MÂLE
 RACOR A T MACHO LATERAL
 CONEXÃO EM "T" COM ROSCA MACHO LATERAL

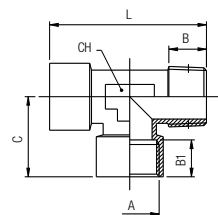

Code	A	B	B1	C	L	CH	Pack.
04050 00 01 B5 NB	M5	4	5.5	11	22	9	10
04050 00 01 02 NB	1/8	8	8.5	19.5	37	12	10
04050 00 01 03 NB	1/4	11	11	24.5	47.5	13	10
04050 00 01 04 NB	3/8	11.5	12	27	52.5	16	10
04050 00 01 05 NB	1/2	14	15	32	61.5	20	10
04050 00 01 07 NT	3/4	14.5	16.5	36.5	68.5	27	10
04050 00 01 09 NT	1"	16.8	19	45	84	30	5

5000

RACCORDO A L MASCHIO

MALE ELBOW
 WINKELVERSCHRAUBUNG AUSSENGEW.
 EQUERRE MÂLE
 RACOR A L MACHO
 CONEXÃO EM "L" COM ROSCA MACHO

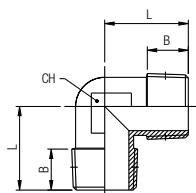

Code	A	B	L	CH	Pack.
05000 00 01 B5 NB	M5	4	11.9	9	10
05000 00 01 02 NB	1/8	7.5	18	11	10
05000 00 01 03 NB	1/4	11	24	13	10
05000 00 01 04 NB	3/8	12	27	17	10
05000 00 01 05 NB	1/2	14	29.5	20	10
05000 00 01 07 NT	3/4	14.5	32	27	10
05000 00 01 09 NT	1"	16.8	39	30	5

5010

RACCORDO A L FEMMINA

FEMALE ELBOW
WINKELVERSCHRAUBUNG INNENGEW.
EQUERRE FEMELLE
RACOR A L HEMBRA
CONEXÃO EM "L" COM ROSCA FÊMEA

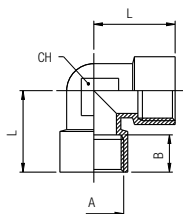

Code	A	B	L	CH	Pack.
05010 00 01 B5 NB	M5	5.5	11	9	10
05010 00 01 02 NB	1/8	8.5	21	11	10
05010 00 01 03 NB	1/4	11	25.5	13	10
05010 00 01 04 NB	3/8	11.5	28	17	10
05010 00 01 05 NB	1/2	15	32	20	10
05010 00 01 07 NT	3/4	16.5	36.5	27	10
05010 00 01 09 NT	1"	19	45	30	5

5020

RACCORDO A L MASCHIO-FEMMINA

MALE-FEMALE ELBOW
WINKELVERSCHRAUBUNG AUSSEN-/INNENGEW.
EQUERRE MÂLE-FEMELLE
RACOR A L MACHO - HEMBRA
CONEXÃO EM "L" MACHO-FÊMEA

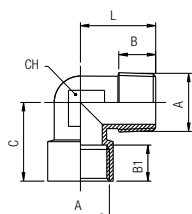

Code	A	B	B1	C	L	CH	Pack.
05020 00 01 B5 NB	M5	4	5.5	11.5	11.5	9	10
05020 00 01 02 NB	1/8	7.5	8.5	21	18	11	10
05020 00 01 03 NB	1/4	11	11	25.5	24	13	10
05020 00 01 04 NB	3/8	11.5	12	28	27	17	10
05020 00 01 05 NB	1/2	14	15	32	29.5	20	10
05020 00 01 07 NT	3/4	14.5	16.5	36.5	32	27	10
05020 00 01 09 NT	1"	16	19	45	39	30	5

5050

RACCORDO A STAFFA 90° FEMMINA

FEMALE BRACKET FITTING 90°
WANDBEFESTIGUNG 90° INNENGEW.
APPLIQUE MURALE
RACOR A L FIJACIÓN 90° CON SOPORTE
CONEXÃO EM "L" COM ROSCA FÊMEA E SUPORTE DE FIXAÇÃO

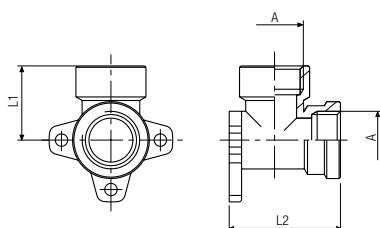

Code	A	L1	L2	Pack.
05050 00 01 05 NB	1/2	27	40.5	10

6000

RACCORDO A Y 90° MASCHIO CENTRALE

CENTRAL MALE Y 90°
Y-Verschraubung 90° AUSSEN-/INNENGEW.
Y EGAL À 90° MALE AU CENTRE
RACOR A Y 90° MACHO CENTRAL
CONEXÕES EM "Y" 90° ROSCA MACHO CENTRAL

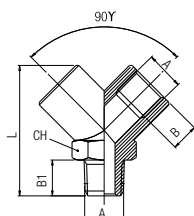

Code	A	B	B1	L	CH	Pack.
06000 00 01 02 NB	1/8	8.5	9	33	14	10
06000 00 01 03 NB	1/4	11	11	37	17	10
06000 00 01 04 NB	3/8	11.5	12.5	46	22	10
06000 00 01 05 NB	1/2	14	16.5	58	26	10

6010

RACCORDO A Y 90° FEMMINA

FEMALE Y 90°

Y-VERSCHRAUBUNG 90° INNENGEW.

Y ÉGAL FEMELLE

RACOR A Y 90° HEMBRA

CONEXÃO EM "Y" COM ROSCA FÊMEA

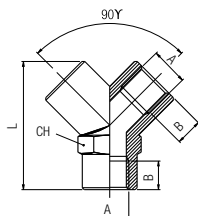

Code	A	B	L	CH	Pack.
06010 00 01 02 NB	1/8	8.5	33	14	10
06010 00 01 03 NB	1/4	11	37	17	10
06010 00 01 04 NB	3/8	11.5	46	22	10
06010 00 01 05 NB	1/2	14	58	26	10

6020

RACCORDO A CROCE FEMMINA

FEMALE EQUAL CROSS

KREUZVERSCHRAUBUNG INNENGEW.

CROIX ÉGALE FEMELLE

RACOR A CRUZ HEMBRA

CONEXÃO CRUZETA COM ROSCA FÊMEA

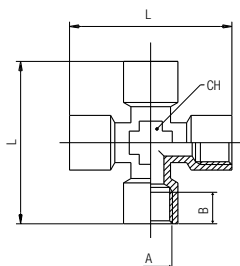

Code	A	B	L	CH	Pack.
06020 00 01 02 NB	1/8	8.5	39	11	10
06020 00 01 03 NB	1/4	11	50	13	10
06020 00 01 04 NB	3/8	12	56	17	10
06020 00 01 05 NB	1/2	15	64	20	10

6025

RACCORDO A CROCE MASCHIO-FEMMINA

MALE-FEMALE EQUAL CROSS

KREUZVERSCHRAUBUNG AUSSEN-/INNENGEW.

CROIX ÉGALE MÂLE/FEMELLE

RACOR A CRUZ MACHO-HEMBRA

CONEXÃO CRUZETA MACHO-FÊMMEA

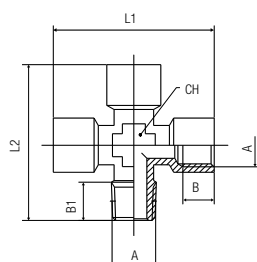

Code	A	B	B1	L1	L2	CH	Pack.
06025 00 01 02 NB	1/8	8.5	8	39	37	11	10
06025 00 01 03 NB	1/4	11	11	50	48.5	13	10
06025 00 01 04 NB	3/8	12	11.5	56	54	17	10
06025 00 01 05 NB	1/2	15	14	64	61	20	10

6030

RACCORDO A CROCE MASCHIO

MALE EQUAL CROSS

KREUZVERSCHRAUBUNG AUSSENGEW.

CROIX ÉGALE MÂLE

RACOR A CRUZ MACHO

CONEXÃO CRUZETA COM ROSCA MACHO

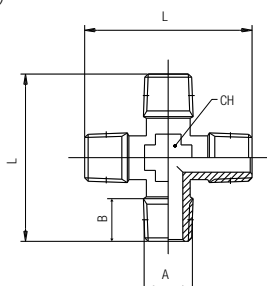

Code	A	B	L	CH	Pack.
06030 00 01 02 NB	1/8	8	35	11	10
06030 00 01 03 NB	1/4	11	47	13	10
06030 00 01 04 NB	3/8	11.5	52	17	10
06030 00 01 05 NB	1/2	14	58	20	10

6040

RACCORDO A CROCE IN ALLUMINIO

ALUMINIUM TEE CROSS
KREUZVERTEILER AUS ALUMINIUM
CROIX DE DISTRIBUTION EN ALUMINIUM
RACOR A CRUZ EN ALUMINIO
CONEXÃO CRUZETA EM ALUMÍNIO

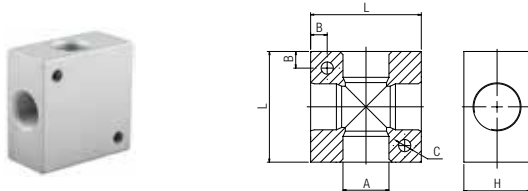

Code	A	L	H	B	C	Pack.
06040 00 11 02 AG	1/8	25	15	4.3	4.5	10
06040 00 11 03 AG	1/4	40	20	6.5	5.5	10
06040 00 11 04 AG	3/8	50	25	7.5	5.5	5
06040 00 11 05 AG	1/2	50	30	7.5	5.5	5

6047

RIPARTITORE IN ALLUMINIO

ALUMINIUM DISTRIBUTION MANIFOLD
VERTEILERBLOCK AUS ALUMINIUM
NOURRICE DE DISTRIBUTION EN ALUMINIUM
REGLETA SIMPLE EN ALUMINIO
DISTRIBUIDOR EM ALUMÍNIO

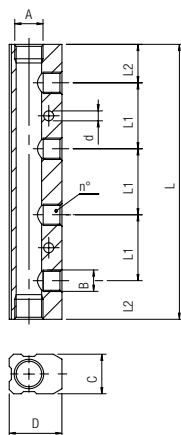

Code	A	B	n°	C	D	L1	L2	L	d	Pack.
06047 00 11 AJ AG	1/4	1/8	2	18	24	30	17.5	65	4.5	5
06047 00 11 AK AG	1/4	1/8	3	18	24	30	17.5	95	4.5	5
06047 00 11 AW AG	1/4	1/8	4	18	24	30	17.5	125	4.5	5
06047 00 11 BA AG	1/4	1/8	5	18	24	30	17.5	155	4.5	5
06047 00 11 BB AG	1/4	1/8	6	18	24	30	17.5	185	4.5	5
06047 00 11 BC AG	3/8	1/4	2	22	30	36	20	76	5.5	5
06047 00 11 BD AG	3/8	1/4	3	22	30	36	20	112	5.5	5
06047 00 11 BE AG	3/8	1/4	4	22	30	36	20	148	5.5	5
06047 00 11 BF AG	3/8	1/4	5	22	30	36	20	184	5.5	5
06047 00 11 BG AG	3/8	1/4	6	22	30	36	20	220	5.5	5
06047 00 11 ES AG	1/2	3/8	2	26	35	40	25	90	5.5	5
06047 00 11 ET AG	1/2	3/8	3	26	35	40	25	130	5.5	5
06047 00 11 EU AG	1/2	3/8	4	26	35	40	25	170	5.5	5
06047 00 11 EV AG	1/2	3/8	5	26	35	40	25	210	5.5	5
06047 00 11 EZ AG	1/2	3/8	6	26	35	40	25	250	5.5	5

6048

RIPARTITORE DOPPIO IN ALLUMINIO

ALUMINIUM DOUBLE DISTRIBUTION MANIFOLD
DOPPELTER VERTEILERBLOCK AUS ALUMINIUM
NOURRICE DE DISTRIBUTION DOUBLE EN ALUMINIUM
REGLETA DOBLE EN ALUMINIO
DISTRIBUIDOR DUPLO EM ALUMÍNIO

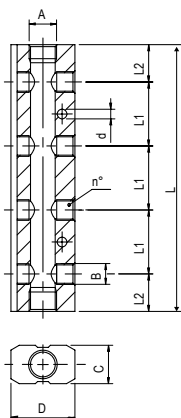

Code	A	B	n°	C	D	L1	L2	L	d	Pack.
06048 00 11 AJ AG	1/4	1/8	2	18	30	30	17.5	65	4.5	5
06048 00 11 AK AG	1/4	1/8	3	18	30	30	17.5	95	4.5	5
06048 00 11 AW AG	1/4	1/8	4	18	30	30	17.5	125	4.5	5
06048 00 11 BA AG	1/4	1/8	5	18	30	30	17.5	155	4.5	5
06048 00 11 BB AG	1/4	1/8	6	18	30	30	17.5	185	4.5	5
06048 00 11 BC AG	3/8	1/4	2	22	38	36	20	76	5.5	5
06048 00 11 BD AG	3/8	1/4	3	22	38	36	20	112	5.5	5
06048 00 11 BE AG	3/8	1/4	4	22	38	36	20	148	5.5	5
06048 00 11 BF AG	3/8	1/4	5	22	38	36	20	184	5.5	5
06048 00 11 BG AG	3/8	1/4	6	22	38	36	20	220	5.5	5
06048 00 11 ES AG	1/2	3/8	2	26	44	40	25	90	5.5	5
06048 00 11 ET AG	1/2	3/8	3	26	44	40	25	130	5.5	5
06048 00 11 EU AG	1/2	3/8	4	26	44	40	25	170	5.5	5
06048 00 11 EV AG	1/2	3/8	5	26	44	40	25	210	5.5	5
06048 00 11 EZ AG	1/2	3/8	6	26	44	40	25	250	5.5	5

6070

RACCORDO A L MASCHIO-FEMMINA

MALE-FEMALE ELBOW FITTING
WINKELVERSCHRAUBUNG AUSSEN-/INNENGEW.
RACCORD EQUERRE MÂLE/FEMELLE
RACOR A L MACHO HEMBRA
CONEXÃO EM "L" MACHO-FÊMEA

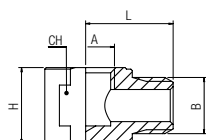

Code	A	B	H	L	CH	Pack.
06070 00 01 2W NB	1/8	1/8	13	15	13	10
06070 00 01 6W NB	1/4	1/4	18	19	18	10

6080

RACCORDO A T MASCHIO-FEMMINA-FEMMINA

MALE-FEMALE-FEMALE TEE FITTING

T-VERSCHRAUBUNG AUSSEN-/INNEN-/INNENGEW.

RACCORD TÉ MÂLE / FEMELLE

RACOR A T MACHO-HEMBRA-HEMBRA

CONEXÃO EM "T" MACHO-FÊMEA

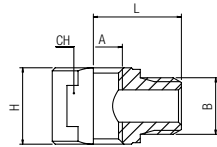

Code	A	B	H	L	CH	Pack.
06080 00 01 2W NT	1/8	1/8	13	15	13	10
06080 00 01 6W NT	1/4	1/4	18	18.5	18	10

6090

ANELLO ORIENTABILE A L FEMMINA

FEMALE SINGLE BANJO BODY

RINGANSCHLUSS INNENGEW.

CORPS BANJO FEMELLE

ANILLO ORIENTABLE HEMBRA

ANEL ORIENTÁVEL EM "L" COM ROSCA FÊMEA

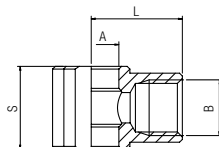

Code	B	A	L	S	Pack.
06090 00 01 02 NB	1/8	10	16.5	15	10
06090 00 01 03 NB	1/4	13	22	17	10
06090 00 01 04 NB	3/8	16.7	26	20	10

82205

NIPPLA MASCHIO CONICO - NPTF

NIPPLE TAPER - NPTF

DOPPELNIPPEL KONISCH - NPTF

MAMELON DOUBLE CONIQUE - NPTF

MACHÓN CÓNICO - NPTF

NIPLE CÔNICA - NPTF

New

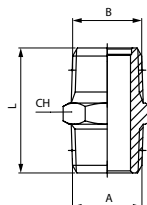

Code	A BSPT	B NPTF	L	CH	Pack.
82205 00 01 2W NB	1/8	1/8	20,5	12	10
82205 00 01 6W NB	1/4	1/4	29	14	10
82205 00 01 AB NB	3/8	3/8	29,5	18	10
82205 00 01 AG NB	1/2	1/2	36,5	22	10
82205 00 01 AN NB	3/4	3/4	40,5	27	10

82241

New

ADATTATORE FEMMINA CILINDRICO - MASCHIO NPTF

ADAPTER FEMALE BSP - MALE NPTF

GEWINDESTUTZEN IG BSP - AG NPTF

ADAPTATEUR FEMELLE BSP - MÂLE NPTF

ADAPTADOR HEMBRA CILÍNDRICO BSP - MACHO NPTF

ADAPTADOR FÊMEA COM ROSCA PARALELA BSP - MACHO NPTF

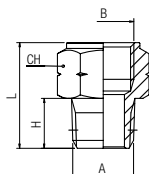

Code	A NPTF	B G	H	L	CH	Pack.
82241 00 01 8K NB	10/32 UNF	M5	14.5	12	8	10
82241 00 01 2W NB	1/8	1/8	8.5	19.5	14	10
82241 00 01 6W NB	1/4	1/4	13	27	17	10
82241 00 01 AB NB	3/8	3/8	13	28	22	10

82242

ADATTATORE FEMMINA NPTF - MASCHIO CILINDRICO

ADAPTER FEMALE NPTF - MALE G THREAD

GEWINDESTUTZEN IG NPTF - AG BSP

ADAPTATEUR FEMELLE NPTF - MÂLE BSP

ADAPTADOR HEMBRA NPTF - MACHO BSP

ADAPTADOR FÊMEA NPTF - MACHO BSP

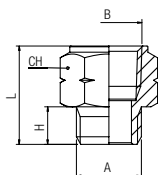

Code	A G	B NPTF	H	L	CH	Pack.
82242 00 01 2W NB	1/8	1/8	6	17	14	10
82242 00 01 6W NB	1/4	1/4	8	23	17	10
82242 00 01 AB NB	3/8	3/8	9	24	22	10
82242 00 01 AG NB	1/2	1/2	12	31.5	27	10

dB*

Livello di rumore in (dB) a 6 bar - Noise level in (dB) at 6 bar - Geräuschpegel (dB) bei 6 bar
Niveau sonore (dB) à 6 bar - Nivel de ruido en (dB) a 6 bar - Nivel de ruído em (dB) a 6 bar

7000

SILENZIATORE

SILENCER
SCHALLDÄMPFER
SILENCIEUX D'ÉCHAPPEMENT
SILENCIADOR
SILENCIADOR

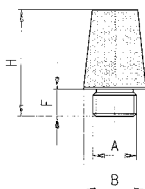

Code	A	F	B	H	dB*	Pack.
07000 00 001	1/8	4.5	12.5	21	81	10
07000 00 002	1/4	6	15	25	83	10
07000 00 003	3/8	8.5	19	34.5	87	10
07000 00 004	1/2	8	23	43	90	10
07000 00 005	3/4	9	30	50	92 a 4 Bar	10
07000 00 006	1"	11	37	60.5	92 a 4 Bar	10

	min	max
Temperature	- 10 °C	+ 80 °C
Pressure		10 bar
Soglia di filtrazione - Filtration threshold - Filterfeinheit Capacité de filtration - Grado de filtración - Limite de filtragem		50 µm

7005

SILENZIATORE REGOLABILE

SILENCER ADJUSTABLE
SCHALLDÄMPFER REGULIERBAR
SILENCIEUX D'ÉCHAPPEMENT RÉGLABLE
SILENCIADOR REGULABLE
SILENCIADOR AJUSTÁVEL

New

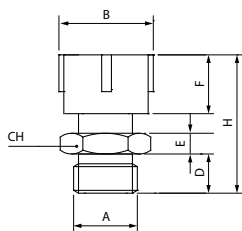

Code	A	F	B	H _{min}	H _{max}	D	E	CH	Pack.
07005 00 001	1/8	12	15	25	27	8	4	14	10
07005 00 002	1/4	14	18.5	28	30	8	4	17	10
07005 00 003	3/8	16	23.5	33	38	10	5	22	10
07005 00 004	1/2	18	28	39	46	12	7	27	10

	min	max
Temperature	- 20 °C	+ 150 °C
Pressure		10 bar
Soglia di filtrazione - Filtration threshold - Filterfeinheit Capacité de filtration - Grado de filtración - Limite de filtragem		50 µm

7010

SILENZIATORE

SILENCER
SCHALLDÄMPFER
SILENCIEUX D'ÉCHAPPEMENT
SILENCIADOR
SILENCIADOR

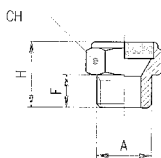

Code	A	F	H	CH	dB*	Pack.
07010 00 001	1/8	6	14	13	73	10
07010 00 002	1/4	7	17	16	74	10
07010 00 003	3/8	8	18	19	85	10
07010 00 004	1/2	10	20	24	89	10
07010 00 005	3/4	10	23	30	90	10

	min	max
Temperature	- 10 °C	+ 80 °C
Pressure		12 bar
Soglia di filtrazione - Filtration threshold - Filterfeinheit Capacité de filtration - Grado de filtración - Limite de filtragem		100 µm

7020

SILENZIATORE CON RETE IN FILO DI ACCIAIO INOX 304

SILENCER WITH WIRE MESH STAINLESS STEEL 304
SCHALLDÄMPFER MIT EDELSTAHLDRAHT 304
SILENCIEUX D'ÉCHAPPEMENT AVEC FILS EN ACIERS INOXYDABLES 304
SILENCIADOR CON ALAMBRE DE ACERO INOXIDABLE 304
SILENCIADOR FIO DE ACO INOXIDAVEL 304

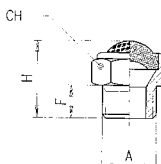

Code	A	F	H	CH	dB*	Pack.
07020 00 001	M5	4	9	8	-	10
07020 00 002	1/8	6	15	13	74	10
07020 00 003	1/4	7	18	16	72	10
07020 00 004	3/8	8	20	19	88	10
07020 00 005	1/2	10	22	24	90	10
07020 00 006	3/4	10	26	30	90	10
07020 00 007	1"	12	28	36	92	10

	min	max
Temperature	- 10 °C	+ 80 °C
Pressure		12 bar
Soglia di filtrazione - Filtration threshold - Filterfeinheit Capacité de filtration - Grado de filtración - Limite de filtragem		100 µm

7030

SILENZIATORE

SILENCER
SCHALLDÄMPFER
SILENCIEUX D'ÉCHAPPEMENT
SILENCIADOR
SILENCIADOR

New

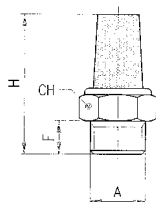

Code	A	F	H	CH	dB*	Pack.
07030 00 001	M5	4	17	8	-	10
07030 00 008	M7x1	5	23	10	75	10
07030 00 002	1/8	6	29	13	81	10
07030 00 003	1/4	7	32	16	82	10
07030 00 004	3/8	8	40	19	85	10
07030 00 005	1/2	9	45	24	-	10
07030 00 006	3/4	10	56	30	-	10
07030 00 007	1"	12	66	36	-	10

	min	max
Temperature	- 10 °C	+ 80 °C
Pressure		10 bar
Soglia di filtrazione - Filtration threshold - Filterfeinheit <i>Capacité de filtration - Grado de filtración - Limite de filtragem</i>		50 µm

7040

SILENZIATORE

SILENCER
SCHALLDÄMPFER
SILENCIEUX D'ÉCHAPPEMENT
SILENCIADOR
SILENCIADOR

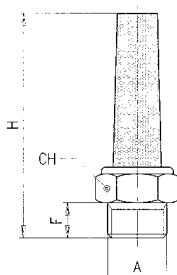

Code	A	F	H	CH	dB*	Pack.
07040 00 001	1/8	6	44	13	76	10
07040 00 002	1/4	7	50	16	75	10
07040 00 003	3/8	8	54	19	88	10
07040 00 004	1/2	9	67	24	89	10
07040 00 005	3/4	9	65	30	-	10

	min	max
Temperature	- 10 °C	+ 80 °C
Pressure		12 bar
Soglia di filtrazione - Filtration threshold - Filterfeinheit <i>Capacité de filtration - Grado de filtración - Limite de filtragem</i>		36 µm

7050

SILENZIATORE

SILENCER
SCHALLDÄMPFER
SILENCIEUX D'ÉCHAPPEMENT
SILENCIADOR
SILENCIADOR

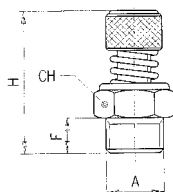

Code	A	F	H min	H max	CH	dB*	Pack.
07050 00 001	1/8	6	26	28	13	72	10
07050 00 002	1/4	8	30	32	15	73	10
07050 00 003	3/8	10	35	38	22	84	10
07050 00 004	1/2	11	37	40	22	88	10

	min	max
Temperature	- 10 °C	+ 80 °C
Pressure		12 bar
Soglia di filtrazione - Filtration threshold - Filterfeinheit <i>Capacité de filtration - Grado de filtración - Limite de filtragem</i>		100 µm

7060

SILENZIATORE A CALZAMENTO PER TUBI

PUSH-ON SILENCER
ÜBERWURFSCHALLDÄMPFER
SILENCIEUX D'ÉCHAPPEMENT À CANULE
SILENCIADOR RÁPIDO
SILENCIADOR PUSH-ON

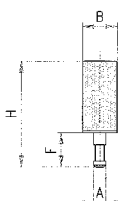

Code	Tube	A	F	B	H	dB*	Pack.
07060 00 002	5/3	3.5	8	8	25.5	-	10
07060 00 003	6/4	5	10	8	26	-	10

	min	max
Temperature	- 10 °C	+ 80 °C
Pressure		10 bar
Soglia di filtrazione - Filtration threshold - Filterfeinheit <i>Capacité de filtration - Grado de filtración - Limite de filtragem</i>		50 µm

7070

SILENZIATORE IN RESINA (POM) CON MATERIALE PP FONOASSORBENTE
 SILENCER MADE IN RESIN (POM) WITH PP SOUNDPROOFING MATERIAL
 SCHALLDÄMPFER AUS ACETAL MIT KUNSTSTOFFWOLLE
 SILENCIEUX EN ACETAL AVEC RÉSINE
 SILENCIADOR DE RESINA (POM) CON MATERIAL PP FONOAABSORBENTE
 SILENCIADOR EM RESINA (POM) COM MATERIAL PP A PROVA DE SOM

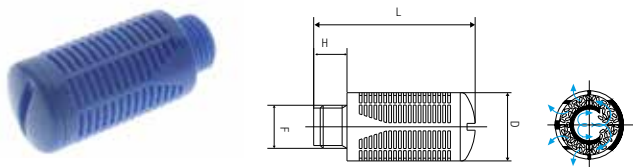

Code	F	H	D	L	dB*	Pack.
07070 00 001	1/8	6	15	32.5	87	10
07070 00 002	1/4	8	19.5	43	84	10
07070 00 003	3/8	11	24.5	58	90	10
07070 00 004	1/2	11	24.5	58	90	10
07070 00 005	3/4	18	48	115	91	5
07070 00 006	1"	18	48	115	90	5

	min	max
Temperature	- 10 °C	+ 50 °C
Pressure	6 bar	

7080

SILENZIATORE IN PA66 E FELTRO
 SILENCER MADE IN PA66 WITH FELT
 SCHALLDÄMPFER PA66 MIT FILZ
 SILENCIEUX EN PA66 AVEC DU FEUTRE
 SILENCIADOR EN PA66 Y FILTRO
 SILENCIADOR EM PA66 E FELTRO

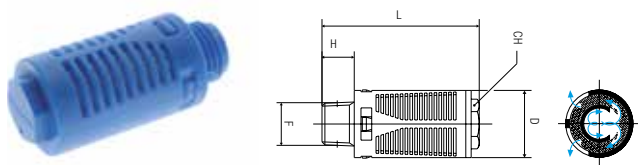

Code	F	H	D	L	CH	dB*	Pack.
07080 00 001	1/8	6	16	34	2	87	10
07080 00 002	1/4	8	19	44	12	90	10
07080 00 003	3/8	10	24	56	17	92	10
07080 00 004	1/2	10	24	56	17	92	10
07080 00 005	3/4	18	48	115	-	-	5
07080 00 006	1"	18	48	115	-	-	5

	min	max
Temperature	- 10 °C	+ 70 °C
Pressure	6 bar	

Attenuazione del suono

IT

Il diagramma mostra la distribuzione della frequenza dell'energia del suono da un getto d'aria ad una pressione di circa 6 bar da un tipico scarico di uscita di una valvola pneumatica da 1/2".

La zona critica fra 1 e 4 KHz, è la zona dove l'udito umano è più sensibile e dove gli effetti psicologici agli alti livelli di rumore sono più dannosi.

Come si nota dal diagramma l'attenuazione del suono è di circa 20-25 dB ad una pressione di 6 bar.

Sound Attenuation

GB

In the diagram is shown the frequency distribution of the sound energy in an 6 bar air jet from a typical 1/2" control valve exhaust port.

The critical region is that between 1 and 4 KHz, the range where psychological effects at high noise levels are most damaging.

Sound reduction for this silencer is approx mately 20-25 dB at 6 bar working pressure.

Längsschalldämmung

DE

Dieses Diagramm zeigt die Frequenzverteilung der Schallenergie, bei einem Luftstrahl von 6 bar Druck, aus einem typischen, pneumatischen Ablassventil mit 1/2".

Der kritische Bereich ist jener zwischen 1 und 4 kHz, der Bereich, bei dem die psychologischen Auswirkungen durch hohen Lärmpegel am schädlichsten sind.

Die Schalldämmung durch diesen Schalldämpfer beträgt rund 20-25 dB bei 6 bar Betriebsdruck.

Réduction sonore

FR

Le schéma suivant représente le niveau sonore d'un jet d'air à 6 bar dans un échappement de 1/2".

La zone critique aux bruits où les effets psychologiques sont nocifs se situe dans une plage de 1 à 4 kHz.

Ce silencieux diminue le bruit d'environ 20-25 dB à une pression de travail de 6 bar.

Atenuación del sonido

ES

El diagrama muestra la distribución de la frecuencia del sonido de una muestra de aire a una presión de 6 bar de un típico escape de una válvula neumática de 1/2".

La zona crítica entre 1 y 4 KHz, es la donde el oído humano es más sensible y donde los efectos psicológicos a los altos niveles de sonido son más dañinos.

Como se observa en el diagrama la atenuación del sonido es de cerca de 20-25 dB a una presión de 6 bar.

Atenuação acústica

PT

O diagrama mostra a distribuição da frequência da energia do som de um jato de ar a uma pressão pneumática de cerca de 6 bar de um típico escape de saída de uma válvula pneumática de 1/2".

A zona crítica entre 1 e 4 KHz, é a zona onde a audição humana é mais sensível e onde os efeitos psicológicos dos ruído podem causar maiores danos.

Como se pode notar no diagrama, a atenuação do som é de cerca de 20-25 dB a uma pressão de trabalho de 6 bar.

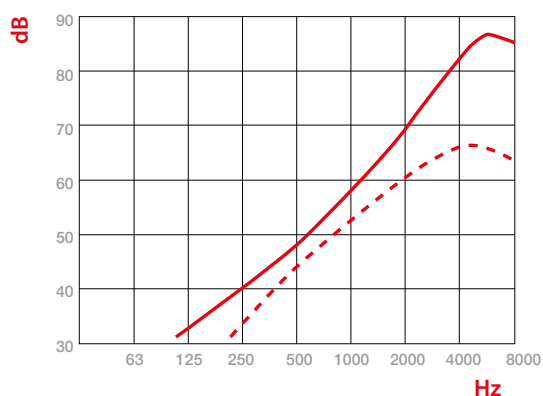

dB re 2x10⁻⁵ N/m²

Livello di pressione acustica
 Octave band sound pressure levels
 Schalldruck Pegel
 Niveau de pression acoustique
 Nivel de presión acústica
 Nivel de pressão sonora

Hz

Frequenza acustica
 Octave band centre frequencies
 Akustische Frequenz
 Fréquence acoustique
 Frecuencia acústica
 Frequência acústica

—

Scarico libero
 Exhaust to atmosphere
 Kostenlose Auspuff
 Échappement Libre
 Escape libre
 Descarga livre

- - - -

Scarico silenziato
 Silenced exhaust
 Schalldämpfer
 Silencieux d'échappement
 Escape silenciado
 Silenciador de escape

AS7100

SILENZIATORE IN POLIETILENE PER RACCORDI AUTOMATICI

POROUS POLYETHYLENE SILENCER FOR PUSH-IN
 STECK-SCHALLDÄMPFER POLYETHYLEN
 SILENCIEUX ENCLIQUETABLE EN POLYÉTHYLÈNE
 SILENCIADOR EN POLIETILENO PARA RACORDAJE AUTOMÁTICO
 SILENCIADOR EM POLIETILENO PARA CONEXÃO PUSH-IN

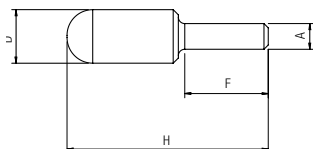

Code	A	F	H±3	D	Pack.
AS710 00 001	4	14	32	7,5	10
AS710 00 002	6	17	45	13	10
AS710 00 003	8	18	43,5	14	10
AS710 00 004	10	22,7	57,5	16	10
AS710 00 005	12	24,5	82	19	10

	min	max
Temperature	- 15 °C	+ 100 °C
Pressure		10 bar
Soglia di filtrazione - Filtration threshold - Filterfeinheit Capacité de filtration - Grado de filtración - Limite de filtragem		75 µm

7100

SILENZIATORE IN POLIETILENE

POROUS POLYETHYLENE SILENCER
 SCHALLDÄMPFER POLYETHYLEN
 SILENCIEUX EN POLYÉTHYLÈNE
 SILENCIADOR EN POLIETILENO
 SILENCIADOR EM POLIETILENO

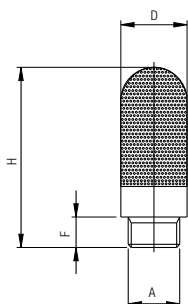

Code	A	F	H	D	Pack.
07100 00 001	M5	4	23	6,5	10
07100 00 002	1/8	6	34	12,5	10
07100 00 003	1/4	7	42,5	15,5	10
07100 00 004	3/8	11,5	67,5	18,5	10
07100 00 005	1/2	11	78	23,5	10
07100 00 006	3/4	15,5	130	38,5	5
07100 00 007	1"	19,5	160	49	5

	min	max
Temperature	- 15 °C	+ 100 °C
Pressure		10 bar
Soglia di filtrazione - Filtration threshold - Filterfeinheit Capacité de filtration - Grado de filtración - Limite de filtragem		75 µm

GRAFICO SILENZIATORE 7110 1/4 - PRESSIONE A 0.254 BAR

TEST GRAPH 7110 1/4" - 0.254 BAR PRESSURE
 GRAFIK FÜR 7110 1/4 - 0.254 BAR DRUCK
 GRAPHIQUE POUR 7110 1/4 - 0.254 BAR PRESSION
 GRÁFICA PARA 7110 1/4 - 0.254 BAR DE PRESIÓN
 GRÁFICO PARA 7110 1/4 - 0.254 BAR DE PRESSÃO

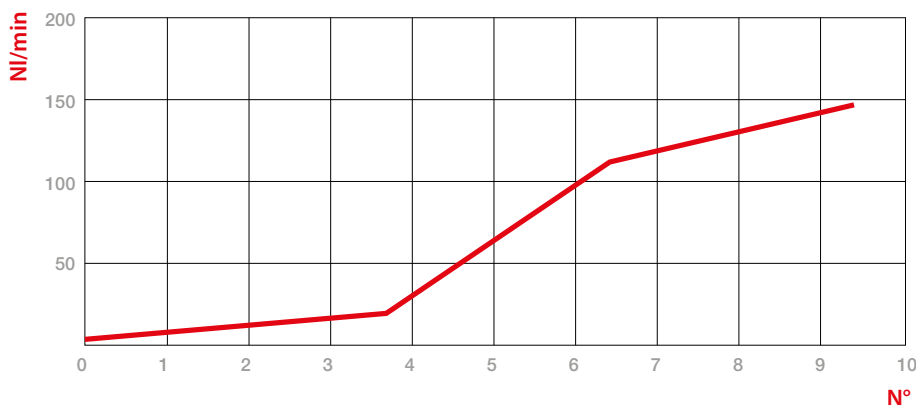

NI/min

Portata
 Flow
 Durchfluss
 Débit
 Caudal
 Vazão

N°

Giri vite di regolazione
 Adjustment screw turns
 Umdrehungen an der einstellnadel
 Nombre de tours de réglage
 Giros de tornillo regulador
 Numero de voltas agulha ajuste

IT

L'unione di un'accurata e facile regolazione con gli elementi dei silenziatori porosi in polietilene aumenta quelle che sono le prestazioni di questo articolo, le cui caratteristiche sono riportate nel grafico.

GB

The combination of accurate and easy adjustment with the porous polyethylene silencing increase the performance of this article, which characteristics are shown in the diagram.

DE

Die Kombination von präziser und einfacher Regulierung, mit einem Schalldämpfer aus porösem Polyethylen, erhöhen die Leistungsfähigkeit dieses Artikels, dessen Merkmale im folgenden Diagramm dargestellt werden:

FR

Le réglage précis et facile du silencieux en polyéthylène permet d'augmenter les performances de cet article. Ces performances sont indiquées dans le diagramme.

ES

La unión de una curada y fácil regulación con los elementos del silenciador poroso en polietileno aumentan las prestaciones de este artículo, las características del cual son representadas en el gráfico adjunto.

PT

A união de uma precisa e fácil regulagem aos elementos silenciadores porosos em polietileno aumenta significativamente a performance do silenciador, cujas características podem ser verificadas no gráfico ao lado.

7110

SILENZIATORE IN POLIETILENE CON REGOLAZIONE DI SCARICO

POROUS POLYETHYLENE RESTRICTOR SILENCER

SCHALLDÄMPFER POLYETHYLEN MIT EINSTELLBARER ABLUFT

SILENCIEUX RÉGLEUR DE DÉBIT

SILENCIADOR EN POLIETILENO CON REGULACIÓN DE ESCAPE

SILENCIADOR EM POLIETILENO COM REGULAGEM DE ESCAPE

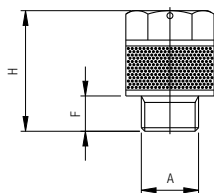

Code	A	F	H	CH1	CH2	Pack.
07110 00 001	M5	5	16	8	1.5	10
07110 00 002	1/8	6	20.5	13	2.5	10
07110 00 003	1/4	7	29	15	4	10
07110 00 004	3/8	8	38	20	6	10
07110 00 005	1/2	10	50	25	8	10

	min	max
Temperature	- 15 °C	+ 100 °C
Pressure		10 bar
Soglia di filtrazione - Filtration threshold - Filterfeinheit <i>Capacité de filtration - Grado de filtración - Limite de filtragem</i>		75 µm

7120

SILENZIATORE A PASTIGLIA CON TAGLIO CACCIAVITE

PAD SILENCER WITH SLOT FOR SCREWDRIVER

MINI-SCHALLDÄMPFER

SILENCIEUX COMPACT

SILENCIADOR DE PASTILLA CON CORTE PARA DESTORNILLADOR

SILENCIADOR TIPO PASTILHA COM FENDA PARA CHAVE

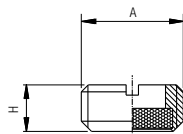

Code	A	H	Pack.
07120 00 001	1/8	4	10
07120 00 002	1/4	6	10
07120 00 003	3/8	6	10
07120 00 004	1/2	9	10
07120 00 005	3/4	10	10
07120 00 006	1"	10	10

	min	max
Temperature	- 10 °C	+ 80 °C
Pressure		10 bar
Soglia di filtrazione - Filtration threshold - Filterfeinheit <i>Capacité de filtration - Grado de filtración - Limite de filtragem</i>		120 µm

7130

SILENZIATORE A PASTIGLIA FILTRANTE CONICO TAGLIO CACCIAVITE

SILENCER WITH FILTERING PAD - (TAPER) WITH SLOT FOR SCREWDRIVER

MINI-SCHALLDÄMPFER MIT KONUSFILTER

SILENCIEUX COMPACT AVEC CÔNE INTÉRIEUR

SILENCIADOR DE PASTILLA FILTRANTE CÓNICO CON CORTE PARA DESTORNILLADOR

SILENCIADOR TIPO PASTILHA FILTRANTE CÓNICO C/ FENDA PARA CHAVE

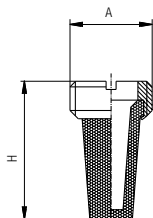

Code	A	H	Pack.
07130 00 001	1/8	15	10
07130 00 002	1/4	18	10
07130 00 003	3/8	21	10
07130 00 004	1/2	27	10
07130 00 005	3/4	36	10
07130 00 006	1"	46	10

	min	max
Temperature	- 10 °C	+ 80 °C
Pressure		10 bar
Soglia di filtrazione - Filtration threshold - Filterfeinheit <i>Capacité de filtration - Grado de filtración - Limite de filtragem</i>		50 µm

7140

SILENZIATORE INTEGRALE CON TAGLIO CACCIAVITE

INTEGRAL SILENCER WITH SLOT FOR SCREWDRIVER

SCHALLDÄMPFER VOLLGESINTERT

SILENCIEUX EN BRONZE FRITTÉ AVEC FENTE DE SERRAGE

SILENCIADOR INTEGRAL CON CORTE PARA DESTORNILLADOR

SILENCIADOR INTEGRAL COM FENDA PARA CHAVE

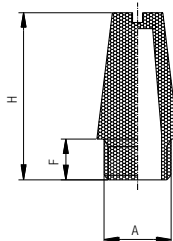

Code	A	H	F	Pack.
07140 00 001	1/8	21	5.5	10
07140 00 002	1/4	27	8.5	10
07140 00 003	3/8	36	11	10
07140 00 004	1/2	44	11	10
07140 00 005	3/4	63	13	10
07140 00 006	1"	75	15	10

	min	max
Temperature	- 20 °C	+ 150 °C
Pressure	10 bar	
Soglia di filtrazione - Filtration threshold - Filterfeinheit <i>Capacité de filtration - Grado de filtración - Limite de filtragem</i>	50 µm	

7150

SILENZIATORE INTEGRALE CON CHIAVE ESAGONALE

INTEGRAL SILENCER WITH HEXAGONAL WRENCH

SCHALLDÄMPFER VOLLGESINTERT

SILENCIEUX EN BRONZE FRITTÉ AVEC 6 PANS DE SERRAGE MÂLE

SILENCIADOR INTEGRAL CON LLAVE HEXAGONAL

SILENCIADOR INTEGRAL COM ENCAIXE PARA CHAVE DE BOCA

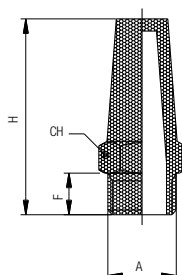

Code	A	CH	H	F	Pack.
07150 00 001	1/8	28	6	13	10
07150 00 002	1/4	31.4	8	17	10
07150 00 003	3/8	36	10	22	10
07150 00 004	1/2	44	12	27	10
07150 00 005	3/4	54	14	32	10
07150 00 006	1"	66	16	41	10

	min	max
Temperature	- 20 °C	+ 150 °C
Pressure	10 bar	
Soglia di filtrazione - Filtration threshold - Filterfeinheit <i>Capacité de filtration - Grado de filtración - Limite de filtragem</i>	50 µm	

New

RACCORDI FILETTATI - CW 510L

CW 510L - NICKEL-PLATED BRASS ADAPTORS
 GEWINDEVERSCHRAUBUNGEN - CW 510L
 ACCESSOIRES DE RACCORDEMENT- ADAPTATEURS LAITON - CW 510L
 RACORDAJE ROSCADO - CW 510L
 ACESSÓRIOS ROSCADOS EM LATÃO NIQUELADO - CW510L



CARATTERISTICHE TECNICHE

TECHNICAL CHARACTERISTICS
 TECHNISCHE ANGABEN
 CARACTÉRISTIQUES TECHNIQUES
 CARACTERÍSTICAS TÉCNICAS
 CARACTERÍSTICAS TÉCNICAS



Norma di Riferimento

Reference standard

Entspricht der Norm

Norme de référence

Normativa de referencia

Norma de referència

1907/2006
REACH ✓

2011/65/CE
RoHS ✓

PED
 2014/68/UE

SILICON
 FREE



Materiali e Componenti **IT**
 La maggior parte degli articoli di questa serie è composta da un unico particolare in CW 510L

Component Parts and Materials **GB**
 The main part of these fittings is made in CW 510L

Komponenten und Materialien **DE**
 Die meisten Artikel in dieser Serie werden aus CW 510L

Matériaux et Composants **FR**
 La majeure partie des raccords de ce chapitre est fabriquée en laiton CW 510L

Materiales y Componentes **ES**
 La mayor parte de los artículos de esta serie está compuesta de un solo material latón CW 510L

Materials e Componentes **PT**
 A maior parte dos itens desta série é fabricada em CW 510L



Misura
 Size
 Grösse
 Dimensions
 Medida
 Tamanho

Pressione consigliata
 Pressure advised
 Empfohlener druck
 Pression conseillée
 Presión recomendada
 Pressão aconselhada

1/8

-0.99 bar ~ 150 bar

1/4

-0.99 bar ~ 100 bar



Temperature massima

Maximum temperature

Maximum temperatur

Température maximale

Temperatura máxima

Temperatura máxima

+ 300 °C



Fluidi compatibili

Aria compressa / Vuoto / Acqua / Vapore / Alimenti

Fluids

Compressed air / Vacuum / Water / Steam / Food

Geeignete Medien

Druckluft / Vakuum / Wasser / Dampf / Lebensmittel

Fluides compatibles

Air comprimé / Vide / Eau / Vapeur / Boissons

Fluidos compatibles

Aire comprimido / Vacío / Agua / Vapor / Alimentos

Fluidos compatíveis

Ar comprimido / Vácuo / Água / Vapor / Alimentos



Tubi di Collegamento

Tubi e raccordi in genere.

IT

Connection Tubes

Tubes and fittings in general.

GB

Geeignete Rohre

Rohre und Verschraubungen im Allgemeinen.

DE

Tubes Conseillés

Raccords et tubes compatibles.

FR

Tubos de Conexión

Tubo y racordaje en general.

ES

Tubos de Conexão

Tubos e conexões em geral.

PT



Filettatura

Gas conica conforme ISO 7.1, BS 21, DIN 2999.
Gas cilindrica conforme ISO 228 Classe A.

IT

Threads

Tapered gas in conformity with ISO 7.1, BS 21, DIN 2999.
Parallel gas in conformity with ISO 228 Class A.

GB

Gewindearten

Konisches Gewinde nach Norm ISO 7.1, BS 21, DIN 2999.
Zylindrisches Gewinde nach Norm ISO 228 Classe A.

DE

Filetages

Filetage conique conforme: ISO 7.1, BS 21, DIN 2999.
Filetage cylindrique conforme: ISO 228 Classe A.

FR

Roscas

Gas cónica conforme ISO 7.1, BS 21, DIN 2999.
Gas cilíndrica conforme ISO 228 Classe A.

ES

Roscas

Gas cônica conforme ISO 7.1, BS 21, DIN 2999.
Gas paralela conforme ISO 228 Classe A.

PT

2000

NIPPLO CONICO

NIPPLE (TAPER)

DOPPELNIPPEL KONISCH

MAMELON DOUBLE CONIQUE

MACHÓN CÓNICO

NIPLE COM ROSCA CÔNICA

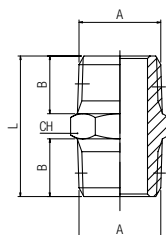

Code	A	B	L	CH	Pack.
02000 00 89 02 00	1/8	7.5	19.5	12	50
02000 00 89 03 00	1/4	11	27	14	50

2020

NIPLO DI RIDUZIONE CONICO

REDUCING NIPPLE (TAPER)
 DOPPELNIPPEL REDUZIERT KONISCH
 MAMELON DOUBLE INÉGAL, CONIQUE
 MACHÓN CÓNICO DE REDUCCIÓN
 NIPLE DE REDUÇÃO COM ROSCA CÔNICA

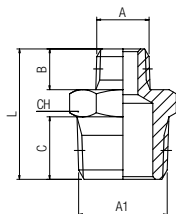

Code	A	A1	B	C	L	CH	Pack.
02020 00 89 AT 00	1/8	1/4	7.5	11	23.5	14	50

3000

MANICOTTO

SLEEVE
 MUFFE
 MANCHON
 MANGUITO
 LUVA

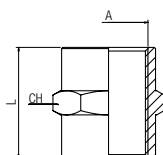

Code	A	L	CH	Pack.
03000 00 89 02 00	1/8	15	14	50
03000 00 89 03 00	1/4	22	17	50

4000

RACCORDO A T FEMMINA

FEMALE TEE
 T-VERSCHRAUBUNG INNENGEW.
 TÉ ÉGAL FEMELLE
 RACOR A T HEMBRA
 CONEXÃO EM "T" COM ROSCA FÊMEA

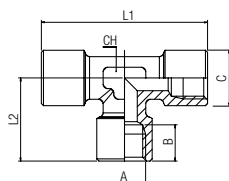

Code	A	B	L2	L1	C	CH	Pack.
04000 00 89 02 00	1/8	8.5	19.5	39	13	12	50
04000 00 89 03 00	1/4	11	24.5	49	16.5	13	25

4040

RACCORDO A T MASCHIO CENTRALE

CENTRE LEG MALE TEE
 T-VERSCHRAUBUNG AUSSENGEW. MITTIG
 TÉ ÉGAL FEMELLE, CENTRE MÂLE
 RACOR A T MACHO CENTRAL
 CONEXÃO EM "T" COM ROSCA MACHO CENTRAL

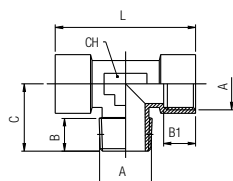

Code	A	B	B1	C	L	CH	Pack.
04040 00 89 02 00	1/8	8	8.5	17.5	39	12	50
04040 00 89 03 00	1/4	11	11	23	49	13	25

4050

RACCORDO A T MASCHIO LATERALE

OFF SET MALE TEE
 T-VERSCHRAUBUNG AUSSENGEW. SEITLICH
 TÉ ÉGAL FEMELLE, EN BOUT MÂLE
 RACOR A T MACHO LATERAL
 CONEXÃO EM "T" COM ROSCA MACHO LATERAL

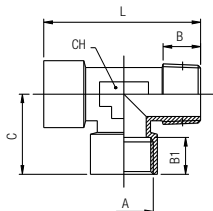

Code	A	B	B1	C	L	CH	Pack.
04050 00 89 02 00	1/8	8	8.5	19.5	37	12	50
04050 00 89 03 00	1/4	11	11	24.5	47.5	13	25

5000

RACCORDO A L MASCHIO

MALE ELBOW
 WINKELVERSCHRAUBUNG AUSSENGEW.
 EQUERRE MÂLE
 RACOR A L MACHO
 CONEXÃO EM "L" COM ROSCA MACHO

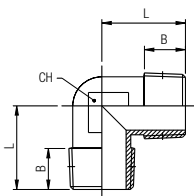

Code	A	B	L	CH	Pack.
05000 00 89 02 00	1/8	7.5	18	11	50
05000 00 89 03 00	1/4	11	24	13	25

5010

RACCORDO A L FEMMINA

FEMALE ELBOW
 WINKELVERSCHRAUBUNG INNENGEW.
 EQUERRE FEMELLE
 RACOR A L HEMBRA
 CONEXÃO EM "L" COM ROSCA FÊMEA

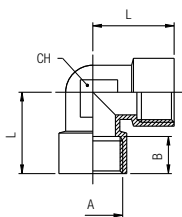

Code	A	B	L	CH	Pack.
05010 00 89 02 00	1/8	8.5	21	11	50
05010 00 89 03 00	1/4	11	25.5	13	25

5020

RACCORDO A L MASCHIO-FEMMINA

MALE-FEMALE ELBOW
 WINKELVERSCHRAUBUNG AUSSEN-/INNENGEW.
 EQUERRE MÂLE-FEMELLE
 RACOR A L MACHO - HEMBRA
 CONEXÃO EM "L" MACHO-FÊMEA

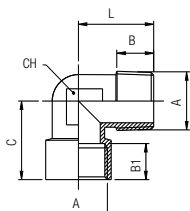

Code	A	B	B1	C	L	CH	Pack.
05020 00 89 02 00	1/8	7.5	8.5	21	18	11	50
05020 00 89 03 00	1/4	11	11	25.5	24	13	25

RACCORDI CON ATTACCO A BAIONETTA

FITTINGS WITH BAYONET CONNECTION
 VERSCHRAUBUNGEN MIT BAJONETT-VERSCHLUSS
 RACCORDS À FERMETURE À BAIONNETTE
 RACORDAJE CON CONEXIÓN A BAYONETA
 CONEXÕES COM ENCAIXE TIPO BAIONETTA



CARATTERISTICHE TECNICHE

TECHNICAL CHARACTERISTICS
 TECHNISCHE ANGABEN
 CARACTÉRISTIQUES TECHNIQUES
 CARACTERÍSTICAS TÉCNICAS
 CARACTERÍSTICAS TÉCNICAS



Norma di Riferimento

- Reference standard
- Entspricht der Norm
- Norme de référence
- Normativa de referencia
- Norma de referência

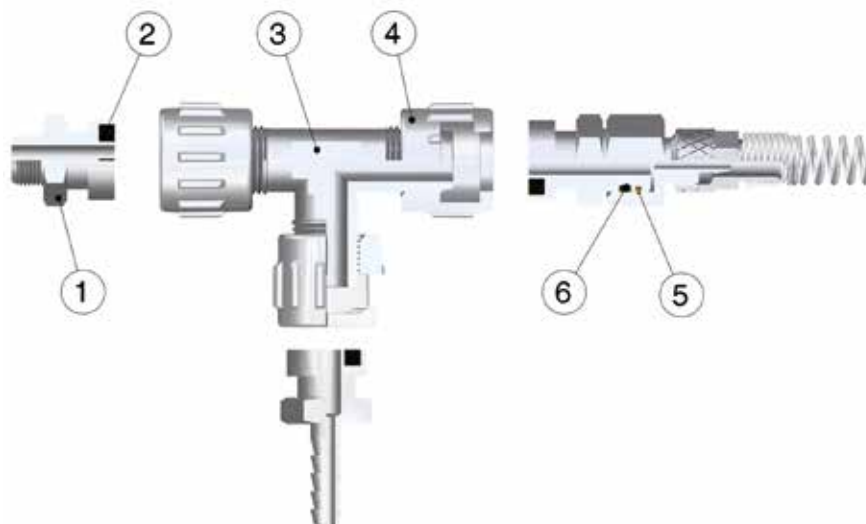
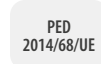

Materiali e Componenti	IT	Component Parts and Materials	GB	Komponenten und Materialien	DE
1 Baionetta in Ottone Nichelato 2 Guarnizione in NBR 90 3 Corpo in ottone nichelato 4 Dado capettato in zama nichelato 5 Seeger in bronzo 6 Guarnizione o-ring in NBR 70		1 Nickel-plated brass Bayonet 2 NBR 90 Seals 3 Nickel-plated brass Body 4 Nickel-plated zamac Milled Nut 5 Bronze Seeger 6 NBR 70 o-ring seal		1 Bajonettanschluss Messing vernickelt 2 Dichtung NBR 90 3 Körper Messing vernickelt 4 Rändelmutter Zamak vernickelt 5 Seegerring Bronze 6 Dichtung O-Ring NBR 70	
Matériaux et Composants	FR	Materiales y Componentes	ES	Materiais e Componentes	PT
1 Raccord baïonnette: laiton nickélé 2 Joint: NBR 90 3 Corps: laiton nickélé 4 Ecrou moleté: Zamac nickélé 5 Circlips: bronze 6 Joint torique: NBR 70		1 Bayoneta en latón niquelado 2 Junta en NBR 90 3 Cuerpo en latón niquelado 4 Tuerca en níquel plateado zamac 5 Seeger en bronce 6 Junta o-ring en NBR 70		1 Baioneta em Latão Niquelado 2 Vedação em NBR 90 3 Corpo em Latão Niquelado 4 Porca recartilhada em zamac Niquelado 5 Anel de retenção tipo Seeger em bronze 6 Vedação o-ring em NBR 70	



Pressioni

- Pressures
- Druckbereich
- Pressions
- Presiones
- Pressões
- 0.99 bar** (-0.099 MPa)
- 15 bar** (1.5 MPa)



Temperature

- Temperatures
- Temperatur
- Températures
- Temperaturas
- Temperaturas
- 20 °C**
- + 70 °C**



Fluidi compatibili

Aria compressa, fluidi e liquidi a bassa pressione compatibili con il tipo di accoppiamento.

Fluids

Compressed air, fluids and liquids at low pressure compatible with the connection.

Geignete Medien

Druckluft, Medien und Flüssigkeiten bei niedrigem Druck die kompatibel mit den Anschlüssen sind.

Fluides compatibles

Aire comprimé et fluides compatibles avec les matériaux des composants.

Fluidos compatibles

Aire comprimido, fluidos o líquidos a baja presión compatibles con el tipo de conexión.

Fluidos compatíveis

Ar comprimido, fluidos e líquidos a baixa pressão compatíveis com o tipo de conexão.



Filettatura	IT	Threads	GB	Gewindearten	DE
Gas cilindrica conforme ISO 228 Classe A. Metrica conforme ISO R/262.		Parallel gas in conformity with ISO 228 Class A. Metric in conformity with ISO R/262.		Zylindrisches Gewinde nach Norm ISO 228 Classe A. Metrisches Gewinde nach Norm ISO R/262.	

Filetages	FR	Roscas	ES	Roscas	PT
Filetage cylindrique conforme: ISO 228 Classe A. Filetage métrique conforme: ISO R/262.		Gas cilíndrica conforme ISO 228 Classe A. Métrica conforme ISO R/262.		Gas paralela conforme ISO 228 Classe A. Métrica conforme ISO R/262.	

1810

RACCORDI PER TUBI IN GOMMA
 FITTING FOR RUBBER HOSE
 VERSCHRAUBUNG FÜR GUMMISCHLAUCH
 RACCORD POUR TUBE CAOUTCHOUC
 RACORDAJE PARA TUBERÍA EN GOMA
 CONEXÃO PARA TUBOS DE BORRACHA

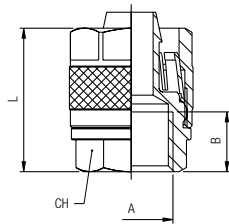

Code	Tube	A	B	L	CH	Pack.
01810 00 003	14/6	1/4	11	30	16	10
01810 00 005	17/8	1/4	11	31	16	10
01810 00 006	19/10	1/4	11	31	17	10
01810 00 007	23/13	1/2	17	36	24	10



RACCORDI PER TUBI IN POLIURETANO INTRECCIATO
 FITTINGS FOR BRAIDED POLYURETHANE HOSES
 VERSCHRAUBUNG FÜR POLYURETHANROHR MIT GEWEBE
 RACCORD POUR TUBE POLYURÉTHANE TRESSÉ
 RACORDAJE PARA TUBO EN POLIURETANO TRENZADO
 CONEXÕES PARA TUBOS EM POLIURETANO TRANÇADO

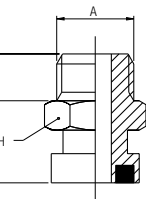

Code	Tube	A	B	L	CH	Pack.
01810 00 001	10/6	1/4	11	30	15	10
01810 00 002	12/8	1/4	11	31	16	10
01810 00 004	15/10	1/4	11	31	17	10



1830

RACCORDO MASCHIO A BAIONETTA
 MALE BAYONET
 BAJONETTANSCHLUSS AUSSENGEW.
 RACCORD DROIT MÂLE
 MACHO A BAYONETA
 CONEXÃO COM ROSCA MACHO E ENCAIXE TIPO BAIONETA

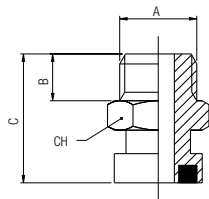

Code	A	B	C	CH	Pack.
01830 00 001	1/8	6	19,5	15	10
01830 00 002	1/4	8	22	15	10
01830 00 003	3/8	9	23	19	10

1831

RACCORDO FEMMINA A BAIONETTA
 FEMALE BAYONET
 BAJONETTANSCHLUSS INNENGEW.
 RACCORD DROIT FEMELLE
 HEMBRA A BAYONETA
 CONEXÃO COM ROSCA FÊMEA E ENCAIXE TIPO BAIONETA

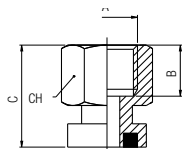

Code	A	B	C	CH	Pack.
01831 00 001	1/8	8,5	19,5	15	10
01831 00 002	1/4	11	22	17	10
01831 00 003	3/8	11	22	20	10

1832

RACCORDO BAIONETTA A RESCA

BAYONET WITH REST
 BAJONETTANSCHLUSS MIT SCHLAUCHTÜLLE
 RACCORD DROIT À CANULE
 ESPIGA A BAYONETA
 CONEXÃO ESPIGÃO E ENCAIXE TIPO BAIONETA

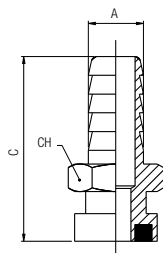

Code	A	C	CH	Pack.
01832 00 001	6	33.5	15	10
01832 00 002	7	33.5	15	10
01832 00 003	8	33.5	15	10
01832 00 004	9	33.5	15	10
01832 00 005	10	33.5	15	10
01832 00 006	12	33.5	15	10

1833

RACCORDO BAIONETTA PORTAGOMMA

BAYONET FOR RUBBER HOSE
 BAJONETTANSCHLUSS FÜR GUMMISCHLAUCH
 RACCORD DROIT POUR TUBE CAOUTCHOUC
 BAYONETA PORTAGOMA
 CONEXÃO PARA MANGUEIRA DE BORRACHA E ENCAIXE TIPO BAIONETA

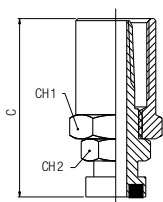

Code	Tube	CH1	CH2	C	Pack.
01833 00 001	14/6	17	15	44.5	10
01833 00 002	17/8	20	15	44.5	10
01833 00 003	19/10	22	15	44.5	10

1840

RACCORDO MASCHIO PORTAGOMMA

MALE FOR RUBBER HOSE
 VERSCHRAUBUNG FÜR GUMMISCHLAUCH AUSSENGEW.
 RACCORD DROIT MÂLE POUR TUBE CAOUTCHOUC
 MACHO PORTAGOMA
 CONEXÃO COM ROSCA MACHO PARA MANGUEIRA DE BORRACHA

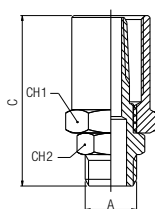

Code	Tube	A	CH1	CH2	C	Pack.
01840 00 008	10/6	1/4	15	17	43	10
01840 00 009	12/8	1/4	15	17	43	10
01840 00 001	14/6	1/4	17	17	43	10
01840 00 010	15/10	1/4	18	17	43	10
01840 00 002	17/8	1/4	20	17	43	10
01840 00 003	17/8	3/8	20	19	44	10
01840 00 006	17/10	1/4	20	17	43	10
01840 00 004	19/10	1/4	22	17	43	10
01840 00 005	19/10	3/8	22	19	44	10

1841

RACCORDO FEMMINA PORTAGOMMA

FEMALE FOR RUBBER HOSE
 VERSCHRAUBUNG FÜR GUMMISCHLAUCH INNENGEW.
 RACCORD DROIT FEMELLE POUR TUBE CAOUTCHOUC
 HEMBRA PORTAGOMA
 CONEXÃO COM ROSCA FÊMEA PARA MANGUEIRA DE BORRACHA

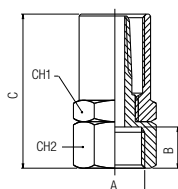

Code	Tube	A	B	C	CH1	CH2	Pack.
01841 00 006	10/6	1/4	11	43	15	17	10
01841 00 007	12/8	1/4	11	43	15	17	10
01841 00 001	14/6	1/4	11	43	17	17	10
01841 00 008	15/10	1/4	11	43	18	17	10
01841 00 002	17/8	1/4	11	43	20	17	10
01841 00 003	17/8	3/8	11.5	43.5	20	20	10
01841 00 004	19/10	1/4	11	43	22	17	10
01841 00 005	19/10	3/8	11.5	43.5	22	20	10

1850

RACCORDO MASCHIO CON DADO CAPETTATO

MALE WITH MILLED NUT

VERSCHRAUBUNG MIT RÄNDELMUTTER AUSSENGEW.

RACCORD DROIT MÂLE AVEC ÉCROU MOLETÉ

MACHO CON TUERCA

CONEXÃO COM ROSCA MACHO E PORCA RECARILHADA

Code	A	B	CH	Pack.
01850 00 001	1/8	6	14	10
01850 00 002	1/4	8	15	10
01850 00 003	3/8	9	19	10

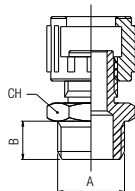

1851

RACCORDO FEMMINA CON DADO CAPETTATO

FEMALE WITH MILLED NUT

VERSCHRAUBUNG MIT RÄNDELMUTTER INNENGEW.

RACCORD DROIT FEMELLE AVEC ÉCROU MOLETÉ

HEMBRA CON TUERCA

CONEXÃO COM ROSCA FÊMEA E PORCA RECARILHADA

Code	A	B	CH	Pack.
01851 00 001	1/4	11	17	10
01851 00 002	3/8	11	20	10

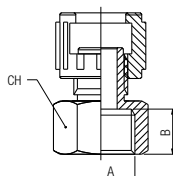

1852

RACCORDO DOPPIO DADO CAPETTATO

DOUBLE MILLED NUT

VERBINDUNGSVERSCHRAUBUNG MIT RÄNDELMUTTERN

RACCORD UNION AVEC ÉCROUS MOLETÉS

UNIÓN CON TUERCA

CONEXÃO DE DUAS PORCAS RECARILHADAS

Code	A	CH	Pack.
01852 00 001	1/4	15	10

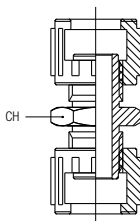

1853

RACCORDO T CON DADI CAPETTATI

TEE WITH MILLED NUTS

T-VERSCHRAUBUNG MIT RÄNDELMUTTERN

RACCORD TÉ AVEC ÉCROUS MOLETÉS

T CON TUERCA

CONEXÃO EM "T" COM PORCAS RECARILHADAS

Code	A	CH	Pack.
01853 00 001	1/4	15	10

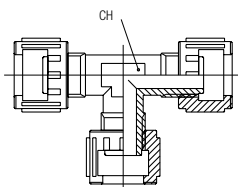

1855

RACCORDO DIRITTO CON ATTACCO A BAIONETTA + DADO CON MOLLA

STRAIGHT FITTING WITH BAYONET CONNECTION + NUT AND SPRING
 VERSCHRAUBUNG MIT BAJONETT-VERSCHLUSS + KNICKSCHUTZFEDER
 RACCORD DROIT AVEC RESSORT DE PROTECTION
 RACOR RECTO A BAYONETA + TUERCA CON MUELLE
 CONEXÃO RETA COM ENCAIXE TIPO BAIONETA + PORCA COM MOLA

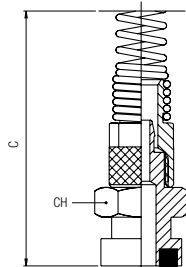

Code	Tube	CH	C	Pack.
01855 00 001	6/4	15	110	10
01855 00 002	8/6	15	115	10
01855 00 003	10/8	15	123	10
01855 00 004	12/10	16	130	10

1860

RACCORDO DIRITTO CON ATTACCO A BAIONETTA + DADO CON MOLLA

STRAIGHT FITTING WITH BAYONET CONNECTION + NUT AND SPRING
 VERSCHRAUBUNG DREHBAR MIT BAJONETT-VERSCHLUSS + KNICKSCHUTZFEDER
 RACCORD DROIT ORIENTABLE AVEC RESSORT DE PROTECTION
 RACOR RECTO GIRATORIO A BAYONETA + TUERCA CON MUELLE
 CONEXÃO RETA ORIENTÁVEL COM ENCAIXE TIPO BAIONETA + PORCA COM MOLA

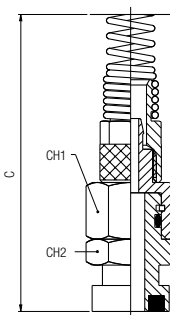

Code	Tube	CH1	CH2	C	Pack.
01860 00 001	6/4	15	15	120	10
01860 00 002	8/6	15	15	125	10
01860 00 003	10/8	15	15	134	10
01860 00 004	12/10	17	17	141	10

1808

DADO CAPETTATO

MILLED NUT
 RÄNDELMUTTER
 ÉCROU MOLETÉ
 TUERCA
 PORCA RECARTILHADA

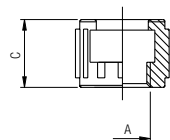

Code	A	C	Pack.
01808 00 80 03 NT	1/4	16	20

1864

GUARNIZIONE DI TENUTA PER RACCORDI CON ATTACCO A BAIONETTA

TIGHTENING SEAL FOR FITTINGS WITH BAYONET CONNECTION
 DICHTUNG FÜR BAJONETT-ANSCHLÜSSE
 JOINT POUR RACCORD À BAJONNETTE
 JUNTA PARA RACORES A BAYONETA
 VEDAÇÃO PARA CONEXÕES COM ENCAIXE TIPO BAIONETA

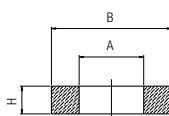

Code	A	B	H	Pack.
01864 00 24 Z7 00	7	13	3	50

RACCORDI PORTAGOMMA PER TUBI IN MATERIALE PLASTICO

HOSE ADAPTERS FOR PLASTIC TUBES
 SCHLAUCHARMATUREN FÜR KUNSTSTOFFROHRE
 RACCORDS À CANULE POUR TUBES PLASTIQUES
 RACORDAJE PORTAGOMA PARA TUBO EN MATERIAL PLÁSTICO
 CONEXÕES ESPIGÃO PARA TUBOS EM MATERIAL PLÁSTICO



CARATTERISTICHE TECNICHE

TECHNICAL CHARACTERISTICS
 TECHNISCHE ANGABEN
 CARACTÉRISTIQUES TECHNIQUES
 CARACTERÍSTICAS TÉCNICAS
 CARACTERÍSTICAS TÉCNICAS



1907/2006

REACH

2011/65/CE

RoHS

PED

2014/68/UE

SILICON

FREE

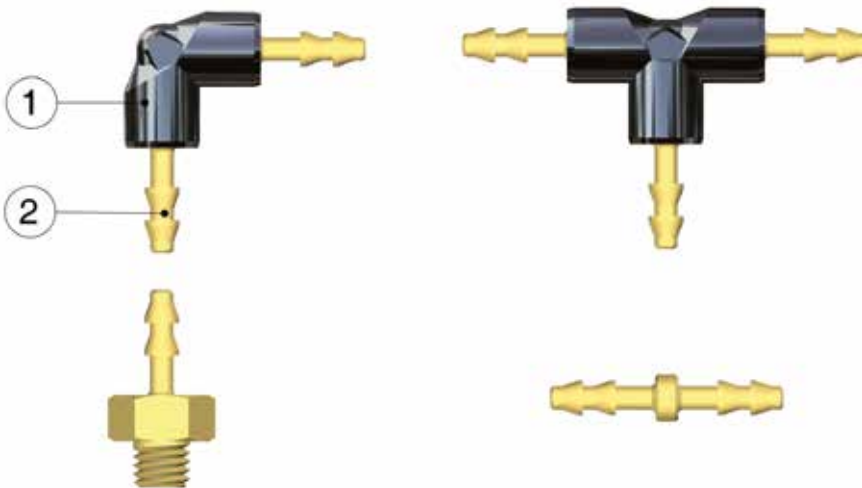

Materiali e Componenti

IT

- 1 Corpo in Tecnopolimero
- 2 Portagomma in ottone

Component Parts and Materials

GB

- 1 Tecnopolymer Body
- 2 Brass Hose Adapter

Komponenten und Materialien

DE

- 1 Körper Technopolymer
- 2 Schlauchtülle Messing

Matériaux et Composants

FR

- 1 Corps: technopolymère
- 2 Canule: laiton

Materiales y Componentes

ES

- 1 Cuerpo en tecnopolímero
- 2 Portagoma en latón

Materiais e Componentes

PT

- 1 Corpo em Tecnopolímero
- 2 Espigão em Latão



Pressioni

Pressures
 Druckbereich
 Pressions
 Presiones
 Pressões

-0.99 bar (-0.099 MPa)

10 bar (1 MPa)



Temperature

Temperatures
 Temperatur
 Températures
 Temperaturas
 Temperaturas

- 10 °C

+ 80 °C



Fluidi compatibili

Aria compressa

Fluids
 Compressed air

Geeignete Medien
 Druckluft

Fluides compatibles
 Air comprimé

Fluidos compatibles
 Aire comprimido

Fluidos compatíveis
 Ar comprimido



Tubi di Collegamento

IT

Tubi in materiale plastico.

Connection Tubes

GB

Plastic tubes.

Geeignete Rohre

DE

Kunststoffrohre.

Tubes Conseillés

FR

Tubes plastiques.

Tubos de Conexión

ES

Tubos en material plástico.

Tubos de Conexão

PT

Tubos em material plástico.



Filettatura

IT

Metrica conforme ISO R/262.

Threads

GB

Metric in conformity with ISO R/262.

Gewindearten

DE

Metrisches Gewinde nach Norm ISO R/262.

Filetages

FR

Filetage métrique conforme: ISO R/262.

Roscas

ES

Métrica conforme ISO R/262.

Roscas

PT

Métrica conforme ISO R/262.

15000

RACCORDO PORTAGOMMA DIRITTO MASCHIO

STRAIGHT HOSE MALE ADAPTOR
 VERSCHRAUBUNG MIT SCHLAUCHTÜLLE AUSSENGEW.
 RACCORD DROIT MÂLE À CANULE
 RACOR PORTAGOMA RECTO MACHO
 CONEXÃO ESPIGÃO RETA COM ROSCA MACHO

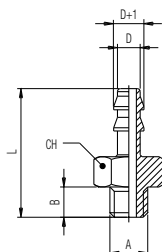

Code	D	A	B	L	CH	Pack.
15000 00 01 4V 00	2	M5	4	17	8	10
15000 00 01 6Q 00	3	M5	4	17	8	10
15000 00 01 0R 00	4	M5	4	18	8	10
15000 00 01 7S 00	6	M5	4	18	8	10

15040

RACCORDO PORTAGOMMA DIRITTO INTERMEDIO

STRAIGHT HOSE ADAPTOR
 VERBINDUNGSVERSCHRAUBUNG MIT SCHLAUCHTÜLLEN
 RACCORD UNION À CANULES
 RACOR PORTAGOMA RECTO INTERMEDIO
 CONEXÃO ESPIGÃO RETA

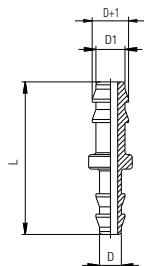

Code	D	D1	L	Pack.
15040 00 01 W9 00	2	2	20	10
15040 00 01 FG 00	3	2	20	10
15040 00 01 X0 00	3	3	20	10
15040 00 01 FH 00	4	3	21	10
15040 00 01 X1 00	4	4	22	10
15040 00 01 FM 00	6	4	22	10
15040 00 01 X4 00	6	6	22	10

15130

RACCORDO PORTAGOMMA A L INTERMEDIO

ELBOW HOSE ADAPTOR
 WINKELVERSCHRAUBUNG MIT SCHLAUCHTÜLLEN
 RACCORD EQUERRE À CANULES
 RACOR PORTAGOMA A L INTERMEDIO
 CONEXÃO ESPIGÃO EM "L"

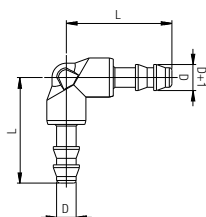

Code	D	L	Pack.
15130 00 001	2	17.5	10
15130 00 002	3	17.5	10
15130 00 003	4	22	10
15130 00 004	6	22	10

15230

RACCORDO PORTAGOMMA A T INTERMEDIO

TEE HOSE ADAPTOR
 T-VERSCHRAUBUNG MIT SCHLAUCHTÜLLEN
 RACCORD TÉ À CANULES
 RACOR PORTAGOMA A T INTERMEDIO
 CONEXÃO ESPIGÃO EM "T"

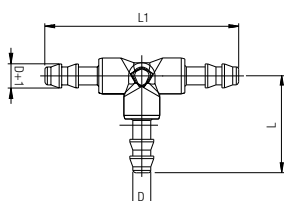

Code	D	L	L1	Pack.
15230 00 001	2	17.5	35	10
15230 00 002	3	17.5	35	10
15230 00 003	4	22	44	10
15230 00 004	6	22	44	10